

# A Guide to Biosafety & Biological Safety Cabinets

---



# Table of Contents

<b>I. Foreword</b>	1
<b>II. Introduction</b>	2
A. The Occurrence of Laboratory-Associated Infections	2
B. Risk Criteria for Establishing Ascending Levels of Containment	2
<b>III. Biological Risk Assessment</b>	2
A. Hazardous Characteristics of an Agent	3
B. Hazardous Characteristics of Laboratory Procedures	3
C. Potential Hazards Associated with Work Practices, Safety Equipment and Facility Safeguards	4
D. Risk-based Approach	4
a. Agents Hazard Identification	4
b. Laboratory Hazard Identification	4
c. The Use of Hazard Control and Appropriate Biosafety level	4
d. Laboratory Personnel Proficiency Regarding Safe Practices and the Integrity of Safety Equipment	5
e. Review of the Risk Assessment with the Institutional Biosafety Committee	5
<b>IV. Principles of Biosafety</b>	5
A. Laboratory Practices and Techniques	5
B. Primary Barriers: Safety Equipment and Personal Protective Equipment	5
C. Secondary Barriers: Facility Design and Construction	6
D. Biosafety Levels	6
<b>V. Laboratory Biosafety Level Criteria</b>	6
A. Biosafety Level 1	7
B. Biosafety Level 2	7
C. Biosafety Level 3	7
D. Biosafety Level 4	9
<b>VI. Biological Safety Cabinets</b>	10
A. International Standards of Biological Safety Cabinets	11
B. Class I Biological Safety Cabinet	12
C. Class II Biological Safety Cabinets	12
a. Class II Type A1/A2	12
b. Class II Type B1/B2	12
D. Class III Biological Safety Cabinet	13
E. Horizontal Laminar Flow “Clean Bench”	13

F.	Vertical Laminar Flow “Clean Bench” .....	14
G.	Working with Chemicals in BSCs .....	14
H.	Radiological Hazards in the BSC .....	14
I.	Selection, Installation and Safe Use of BSCs .....	14
	a. Air Filtration Systems and the Development of Biological Containment Devices .....	14
	b. Selection of a Safety Cabinet through Risk Assessment .....	15
	c. Installation .....	16
	d. Safe Use of BSCs .....	17
	e. Certifications of BSC .....	18
<b>VII.</b>	<b>Good Microbiological Techniques</b> .....	<b>20</b>
<b>A.</b>	<b>Laboratory Techniques</b> .....	<b>20</b>
	a. Proper Handling of Specimen .....	20
	b. Proper use of pipette and pipetting aids .....	20
	c. Dispersal of infectious materials .....	21
	d. Ingestion, eye and skin contact of infectious materials .....	21
	e. Injection and infectious materials .....	21
	f. Separation of serum .....	21
	g. Using centrifuge .....	21
	h. Use of homogenizers, shakers, blenders and sonicators .....	21
	i. Use of tissue grinders .....	22
	j. Care and use of cold storage .....	22
	k. Opening of ampoules .....	22
	l. Storage of ampoules .....	22
	m. Standard precautions with blood and other body fluids .....	22
<b>B.</b>	<b>Contingency Plans and Emergency Procedures</b> .....	<b>22</b>
	a. Contingency plan .....	22
	b. Emergency procedures for microbiological laboratories .....	23
<b>C.</b>	<b>Decontamination and Disinfection</b> .....	<b>24</b>
<b>VIII.</b>	<b>Safety Organization and Training</b> .....	<b>24</b>
<b>A.</b>	<b>Biosafety Officer</b> .....	<b>24</b>
<b>B.</b>	<b>Biosafety Committee</b> .....	<b>25</b>
<b>C.</b>	<b>Support Staff</b> .....	<b>25</b>
	a. Engineering and building maintenance services .....	25
	b. Cleaning (domestic) services .....	25

<b>D.</b>	<b>Training Programs</b> .....	<b>26</b>
	a. Needs assessment .....	26
	b. Establishing training objectives .....	26
	c. Identifying training content and media .....	26
	d. Accounting for individual learning differences .....	26
	e. Specifying learning conditions .....	26
	f. Training evaluation .....	26
	g. Training revision .....	26
<b>IX.</b>	<b>Disinfection, Sterilization and Safety Checklist</b> .....	<b>26</b>
<b>A.</b>	<b>Disinfection and Sterilization</b> .....	<b>26</b>
	a. Definitions .....	26
<b>B.</b>	<b>Safety Checklist</b> .....	<b>28</b>
	a. Laboratory premises .....	28
	b. Storage facilities .....	28
	c. Sanitation and Staff facilities .....	28
	d. Heating and ventilation .....	28
	e. Lighting .....	28
	f. Services .....	29
	g. Laboratory Biosecurity .....	29
	h. Fire prevention and fire protection .....	29
	i. Compressed and liquified gases .....	29
	j. Electrical hazards .....	30
	k. Personal protection .....	30
	l. Health and safety of staff .....	30
	m. Laboratory equipment .....	30
	n. Infectious materials .....	31
	o. Chemicals and radioactive substances .....	31
<b>References</b> .....		<b>32</b>

## I. Foreword

This booklet was developed to provide basic knowledge of biosafety and biological safety cabinets. The information presented is unbiased and generic in nature compiled with help from experienced microbiologists, engineers and safety enclosure users.



## Welcome to Esco

*Esco's Vision is to provide enabling technologies for scientific discoveries to make human lives healthier and safer.*

### About Esco

Esco represents innovation and forward-thinking designs, which are all coupled with the highest standard quality since 1978. The Esco Group of Companies remains dedicated in delivering innovative solutions for the clinical, life sciences, research, industrial, laboratory, pharmaceutical and IVF community. With the most extensive product line in the industry, our products have passed a number of international standards and certifications. Esco operates under ISO 9001, ISO 14001 and ISO 13485.

Today, Esco continues to emerge as a market leader in containment, clean air, pharmaceutical, and laboratory equipment technologies with active sales in more than 100 countries and direct company offices in the top ten geospecific markets.

From our headquarters in Singapore, Esco directs a highly efficient research, product development, manufacturing and customer service program. We are the only company in our market that is completely configured to export most of what we manufacture. Our many languages and culture, customs and traditions, and modern business management techniques blend into a single effort focusing on customer service, one customer at a time. As you learn more about Esco, you will understand why World Class. Worldwide. is more than a phrase. It's part of who we are, where we are from and where we are going.



## II. Introduction

### A. The Occurrence of Laboratory-Associated Infections

Reports of laboratory-associated infections (LAIs) first appeared around the start of the 20th century. Studies conducted by Pike and Sulkin in the year 1978 identified 4,079 LAIs leading to 168 deaths that occurred between 1930 and 1978. Further studies did show that in many of these cases the infected person worked with microbiological agents or was near to another person handling the agent.<sup>1</sup>

20 years following, Harding and Byers revealed 1,267 overt infections with 22 deaths and 663 cases that presented as sub-clinical infections. The findings of Harding and Byers indicated that clinical (diagnostic) and research laboratories accounted for 45% and 51%, respectively, of the total LAIs reported. In contrast to the LAIs reported by Pike and Sulkin before to 1979, which indicated that clinical and research laboratories accounted for 17% and 59%, respectively.<sup>1</sup>

The relative increase of LAIs in clinical laboratories may be due in part to improved employee health surveillance programs that are able to detect sub-clinical infections, or to the use of inadequate containment procedures during the early stages of culture identification. And the publication of the occurrence of LAIs provides an invaluable resource for the microbiological and biomedical community. Reports of LAIs can serve as lessons in the importance of maintaining safe conditions in biological research.<sup>1</sup>

### B. Risk Criteria for Establishing Ascending Levels of Containment

In identifying the four ascending levels of containment, referred to as Biosafety levels (BSL) 1 through 4, the primary risk criteria are: infectivity, the severity of the disease, transmissibility and the nature of the work being conducted. For agents that cause moderate to severe disease, another important risk factor is the origin of the agents- indigenous or exotic. Each level of containment describes the microbiological practices, safety equipment and facility safeguards for the corresponding level of risk associated with handling a particular agent. The basic practices and equipment are appropriate for protocols common to most research and clinical laboratories. The facility safeguards help protect non-laboratory occupants of the building and the public health and environment.<sup>1</sup>

Agent summary statements are included for agents that meet one or more of the following three criteria:

1. the agent is a proven hazard to laboratory personnel working with infectious materials;
2. the agent has a high potential for causing LAIs even though no documented cases exist; and
3. the agent causes grave disease or presents a significant public health hazard.

These statements were prepared by scientists, clinicians, and biosafety professionals by assessing the risk of handling the agents using standard protocols followed in many laboratories. No one should conclude that the absence of an agent summary statement for a human pathogen means that the agent is safe to handle at BSL-1, or without a risk assessment to determine the appropriate level of containment. Laboratory directors should conduct an independent risk assessment before commencing work with an agent or procedure new to the laboratory. There may be situations where a laboratory director should consider modifying the precautionary measures or recommended practices, equipment, and facility safeguards described in an agent summary statement. In addition, laboratory directors should seek guidance when conducting risk assessments. Knowledgeable colleagues; institutional biosafety committees; biosafety officers; and public health, biosafety, and scientific associations are excellent resources.<sup>1</sup>

## III. Biological Risk Assessment

Conducting a risk assessment prior to the start of every laboratory activity involving biohazardous agents is essential to determine the safety of the personnel working directly with the agent. Risk assessment is described by CDC as the process of careful identification and judgment of how hazardous a known or potentially infectious agent or material is, what activities could lead to the exposure of personnel to such agent, how likely for the exposure to result to an infection, and what consequences will probably occur due to such infection. The information gathered in risk assessment will serve as the guide in choosing the appropriate biosafety level that will determine the microbiological practices, safety equipment, and facilities that must be utilized in the laboratory to keep the laboratory personnel and the public safe enough from the biohazard agents. Dangerous consequences might result from underestimating the risks presented by biohazard agents while unnecessary financial burden can come from exaggerating the risk control methods, thus careful judgment during risk assessment is critical.<sup>1</sup>

Risk assessment is a responsibility of any microbiological and biomedical laboratory administrators and biosafety professionals. It is their primary role to provide proper training to their laboratory staff with regards to handling biohazardous agents and materials, keeping in mind that awareness and proficiency of the appropriate biosafety level not only protects the personnel working directly with the infectious agents but also the people indirectly associated with the laboratory, including those occupying the same building. It is important to note as well that any research or teaching activity which will involve biohazard agents must be done only upon the approval of a local Institutional Biosafety Committee.<sup>1</sup>

The factors that must be considered in biological risk assessment are agent hazards, laboratory procedure hazards, the training, technical proficiency, and good practices of every laboratory staff to control the hazards, and the efficiency of engineering controls and safety facilities.<sup>1</sup>

## A. Hazardous Characteristics of an Agent

The biohazardous profile of an agent can be characterized according to three main factors, namely: 1) its mode of transmission or route of entry to human or animal beings, 2) the severity of the disease it can cause, and 3) whether preventive measures and disease treatments are available. In the laboratory, the common routes of transmission for biohazard agents are direct skin or mucosal membrane contact, parenteral inoculation through a contaminated syringe needle or sharp objects or bites of infected animals or vectors, ingestion of liquid suspension of an infectious agent, and inhalation of infectious aerosols. The severity of the disease caused by biohazard agents ranges from unlikely to cause disease up to likely to cause serious or lethal disease to a healthy human being. Other factors to consider when describing the risks from a biohazard agent include the dose when it becomes infective, its stability in the environment, the range of hosts it can infect, and its endemic nature. Below table is a general risk group (RG) classification of biohazard agents according to their principal characteristics and route of transmission.<sup>1</sup>

**Table 3.1 Classification of Biological Agents According to Risk Group**

Risk Group	Individual Risk	Community Risk	Implications	Examples
1	Low	Low	Unlikely to cause disease in a healthy adult human	<i>Bacillus subtilis</i> , <i>Naegleria gruberi</i> , Infectious canine, Hepatitis virus, <i>E. coli</i> .
2	Moderate	Limited	Can infect humans through percutaneous injury, ingestion, and mucous membrane exposure and can cause disease that is rarely serious for which preventive or therapeutic interventions are often available.	Measles virus, Salmonellae, <i>Toxoplasma spp.</i> , Hepatitis A, B, and C viruses, HIV
3	High	Low	Indigenous or exotic agents with potential for aerosol transmission and may cause serious or lethal disease to human for which preventive or therapeutic interventions may be available	<i>Mycobacterium tuberculosis</i> , Saint Louis encephalitis virus, <i>Coxiella burnetii</i> , <i>Bacillus anthracis</i> (production level)
4	High	High	Aerosol-transmitted lab infections or related agents with unknown risk of transmission and likely to cause serious or lethal disease to human for which preventive or therapeutic interventions are not usually available	Numerous virus that cause hemorrhagic disease (Ebola, Marburg, Lassa fever, Hantavirus, etc), H5N1 (bird flu) and <i>Yersinia pestis</i> .

Source: *Biosafety in Microbiology and Biomedical Laboratories*, U.S. Department of Health and Human Services, HHS publication (CDC) 99-8395. 4th Edition. April 1999. p 52-53.

The use of genetically modified agents and human or animal cell cultures in the laboratory can also be a source of hazard. For genetically modified agents, a risk assessment must be done by identifying whether the agent's pathogenicity and its susceptibility to antibiotics or other effective treatments have changed significantly with regards to the genetic modifications. Appropriate safety practices and procedures for handling recombinant DNA molecules are described in the NIH Guidelines which can serve as a helpful reference during risk assessment. On the other hand, handling human or animal cell cultures creates a risk of being potentially exposed to hazardous latent and adventitious agents that could be present in the cultured cells or tissues. Identify if the cell cultures contain an etiologic agent, an oncogenic virus, or amphotropic packaging system, in which case the risk classification of the cell culture should be the same as that recommended for the biohazard agent. Any cell lines that are of human/primate origin, derived from lymphoid or tumor tissue, exposed to or transformed by an oncogenic virus or by amphotropic packaging systems, clinical samples, or mycoplasma-containing should be handled at Biosafety Level 2 or higher.<sup>1,3</sup>

## B. Hazardous Characteristics of Laboratory Procedures

Studies concerning laboratory-associated infections have shown that there are five routes of transmission of the biohazard agents, including parenteral inoculation by contaminated syringe needles or sharp objects, contact to skin or mucous membranes by spill and splashes, ingestion due to mouth pipetting, bites or scratches from infected animals, and exposure of the respiratory tract to harmful aerosols. Only 20% of the laboratory-associated infections reported are due to the first four routes of transmission, while 50% of the cases are due to exposure to the sources of infection. Of all possible sources of infection, aerosols are considered as the most serious hazard in the lab, therefore great attention must be given when handling infectious suspensions in the laboratory because of the hazard brought by the potential generation of aerosols.<sup>1</sup>

Aerosols, or the suspensions under pressure released to the air as a fine spray, are considered a serious hazard in the lab because it is in almost every laboratory procedure, can be released undetected due to its small size range and is easily spread widely in an area. Aerosols can be released in any lab procedure (e.g. pipetting) or equipment such as blenders, non-self-contained centrifuges, sonicators, and vortex mixers that are used in the routine handling of infectious suspensions. Once released, these small particles can remain suspended in the air

until they are inhaled and retained in the lungs of people working directly with the agent, of other workers sharing the same laboratory, and of people occupying adjacent rooms receiving the airflow from the contaminated laboratory. An agent's inhalation infective dose, its viability in an aerosol, aerosol concentration and particle size determine the hazardous impact of aerosols.<sup>1</sup>

Bigger droplets of biohazard agents can also be a hazard as serious as the aerosols. The larger the droplet is, the more copies of an infectious agent are being spread. These droplets can infect through the skin and mucous membrane contact since they can easily settle out after being released into the air. Therefore, much attention must be given as well to droplets of biohazards.<sup>1</sup>

### **C. Potential Hazards Associated with Work Practices, Safety Equipment, and Facility Safeguards**

As the first line of defense from biohazard agents, all laboratory personnel working directly with the biohazard agent should be conscientious, careful, and proficient to protect themselves, the other people working in the laboratory, and the public from being exposed to the hazardous agents. Proper training and experience, as well as sufficient knowledge of the hazardous profile of an agent, combined with the use of appropriate personal protective equipment (PPE), good laboratory habits, mindfulness, and concern for others, could greatly reduce the risks associated with handling biohazard agents.<sup>1,2</sup>

Other potential hazards in the laboratory can be obtained from engineering control equipment (e.g. biological safety cabinet) which is often used in the laboratory for a higher degree of protection against biohazards. When the control equipment malfunctions such as in the case of improper airflow or saturated filter, or when it is installed without following the correct installation and environmental requirements, or when it is used without adequate training, the equipment could compromise the safety of the laboratory worker. It is therefore highly important that the laboratory workers are also trained in the correct use and maintenance of the safety equipment, and that annual re-certification or preventive maintenance are done to all engineering control equipment to be used in the laboratory.<sup>1,2</sup>

It is also important to consider the laboratory facilities employed when it comes to the proper containment of the biohazard, especially when involving agents belonging to higher risk groups which are easily transmitted through the air and is lethal to the workers. Help from a biological safety officer, building and facilities staff, and local Institutional Biosafety Committee must be sought for assessment and recommendations when designing and operating laboratories especially when the laboratory might require Biosafety Levels 3 or 4 containment facilities.<sup>1,2</sup>

### **D. Risked-based Approach**

The first step to safety when handling biohazard agents is risk assessment. Although there is no standard way to do a biological risk assessment, a simple structure described in the following paragraphs could serve as a guide to help in conducting risk assessment.<sup>1</sup>

#### **a. Identify first the hazardous agents to be used**

Be knowledgeable of the hazardous profile of the agent, with consideration on the ability of the agent to infect and cause disease to human, the severity of the disease, and the availability of the preventive measures and effective treatments. Whenever possible, identify the known and suspected routes of transmission as well of laboratory infection, the infective dose, the host range, agent stability in the environment, protective immunizations, and attenuated strains of the agent. Excellent resources for information are widely available and guidance from experienced biosafety professionals can also be a great help in doing the risk assessment.<sup>1</sup>

#### **b. Identify the laboratory procedure hazards**

Take note of the information on agent concentration, suspension volume, equipment and procedures that can generate aerosols or droplets of infectious suspensions, use of sharps, the exposure to zoonotic agents (when animals are used), and handling experimentally-generated infectious aerosols. Identify the specific hazards as well associated with the laboratory procedures, especially when the hazards posed by the procedures are not applicable to the agent or when the agent's hazardous profile is not available.<sup>1</sup>

#### **c. Determine the appropriate biosafety level and hazard controls needed**

Determine a potential biosafety level that is the most appropriate for the characteristics of the biohazard agents upon evaluation. Consider the practices, safety equipment, and facilities and understand how all these factors play a significant role in hazard containment. Additional precautionary measures may be required in highly specialized applications. Identify the health profile of every laboratory personnel as well who will be working directly with the agent and will be exposed to the laboratory hazards. Each person can have a varied susceptibility to disease and risk of contracting a laboratory-associated infection, therefore, it is also important to consult a knowledgeable physician.<sup>1</sup>



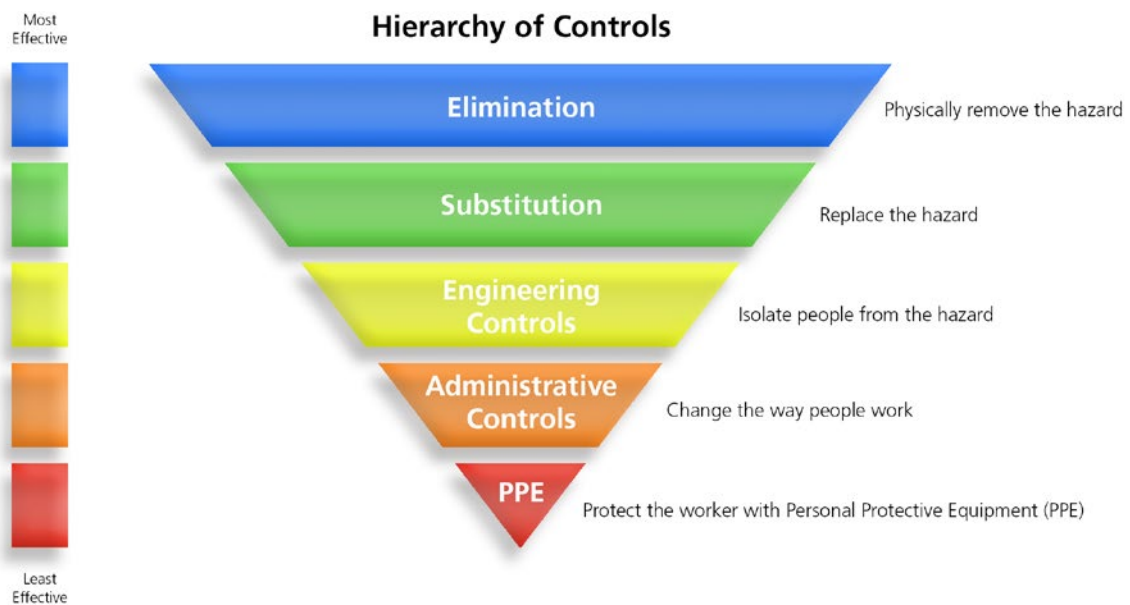

Source: <https://www.cdc.gov/niosh/topics/hierarchy/>

#### d. Evaluate the proficiency regarding safety practices of laboratory personnel and the integrity of the safety equipment

Part of the risk assessment approach is to ensure that the laboratory workers are well-versed technically on the needed microbiological practices and the proper use of safety equipment. Every personnel must be evaluated in their ability to handle biohazardous agents, knowledge of the aseptic techniques and use of safety equipment such as biological safety cabinets, alertness to respond in emergencies, and sense of responsibility in protecting themselves and others in the laboratory. It is also of great importance that the safety equipment required for handling the biohazards are available and functional before the start of any laboratory activity.<sup>1</sup>

#### e. Conduct a review of the risk assessment with the aid of a local Institutional Biosafety Committee

Seek help from knowledgeable and experienced professionals by reviewing with them the risk assessment done and selected safety practices, equipment, and facilities. Protocols that pose a potentially high risk must be reviewed by a local Institutional Biosafety Committee.<sup>1</sup>

## IV. Principles of Biosafety

Biosafety program's main goal is the containment of potentially dangerous biological agents. Containment refers to methods, facilities, and equipment for managing infectious materials in the laboratory environment where they are being handled or maintained. It aims to prevent exposure of laboratory workers and other people from hazardous biological agents.<sup>4</sup>

### A. Laboratory Techniques and Practices

In the process of containment, it is most significant to strictly follow certain laboratory practices and techniques. This includes the knowledge of laboratory workers on the possible harms of infected material, and their training in using laboratory materials to be provided by the director or overall in charge of the laboratory.<sup>4</sup>

In order for laboratory workers to be informed, there should be manuals available which specify the possible hazards in using laboratory equipment and how biohazards may be handled correctly. There should also be a scientist who is trained in risk assessment and in dealing with infected materials. In case the standard procedures are not enough, there should be a laboratory director who can add more safety practices. Add up to all of this is the correct engineering design of the laboratory, safety equipment, and management practices.<sup>4</sup>

### B. Safety Equipment (Primary Barriers)

The different safety equipment for the prevention of exposures to harmful biological agents are biosafety cabinets (BSCs), enclosed containers, and other engineering controls. These are considered as primary barriers and personal protective equipment. The BSCs are mainly used for containing infectious droplets or aerosols from microbiological procedures. It has three types (Class I, II, and III). Class I and II BSCs are open-fronted which protect the laboratory workers and the environment from harmful biological agents. Class II BSCs also prevent biological materials (i.e cell cultures, microbiological stocks) inside it from being contaminated. Class III BSC is gas-tight and offers the highest level of protection to the laboratory workers and the environment. Safety centrifuge cup is also a primary barrier which minimizes aerosol release during centrifugation.<sup>4</sup>

## C. Facility Design and Construction (Secondary Barriers)

It is important for laboratories to have facilities appropriately designed to prevent/minimize the release of harmful biological agents to the environment. Laboratory directors are responsible for the accomplishment of this task.<sup>4</sup>

Facility design and construction are secondary barriers dependent on the risk of transmission of specific agents. For BSL-1 and BSL-2 laboratories, for example, the facility should have isolation from public access, and availability of decontamination facility (i.e. autoclave, and hand washing facilities).<sup>4</sup>

In dealing with the aerosol release, higher levels of primary containment and multiple secondary barriers are needed. Facility design should include specialized ventilation systems, air treatment systems, controlled access zones, airlocks at laboratory entrances, and separate buildings to isolate the laboratory.<sup>4</sup>

## D. Biosafety Levels

When there is an increased concentration of infectious agents in a laboratory, certain biosafety level practices are needed. These are measures in order to contain or isolate harmful infectious agents in a laboratory. For risk assessment of harmful agents, a Biological Safety Officer (BSO) and Institutional Biosafety Committees (IBC) may be of help. There are four biosafety level.<sup>4</sup>

**Biosafety Level 1** is for undergraduate and secondary educational training and teaching laboratories and for other laboratories that use microorganisms which are not pathogenic. Examples are *Bacillus subtilis*, *Nigeria gruberi*, and infectious canine Hepatitis virus. Thus, BSL-1 containment only requires a sink for hand washing.<sup>4</sup>

**Biosafety Level 2** is appropriate for clinical, diagnostic, teaching, and other laboratories which deal with indigenous moderate-risk agents linked with human disease and is present in a community. Examples are the Hepatitis B virus, HIV, *Salmonella*, and *Toxoplasma*. These microorganisms may be used on the open bench as long as there is low production of aerosols.<sup>4</sup>

Hazards may be acquired through ingestion of or exposure of the mucous membrane from the microorganisms. Certain precautions should be taken in handling contaminated materials (i.e. sharp objects). Similarly, procedures involving aerosol should be undertaken in BSC or safety centrifuge cups. Personal protective equipment is also helpful together with hand washing sinks and waste decontamination facilities.<sup>4</sup>

**Biosafety Level 3** applies to clinical, diagnostic, teaching, research, or production facilities handling indigenous or exotic agents with a potential for respiratory transmission that may be a cause for lethal infection. Examples are *Mycobacterium tuberculosis*, St. Louis Encephalitis virus, and *Coxiella burnetii*. Hazards may be acquired through autoinoculation, ingestion, and exposure to infectious aerosols. For containment, procedures should be done in BSC or a gas-tight aerosol generation chamber. Ventilation systems should also be appropriate to reduce the release of hazardous aerosols.<sup>4</sup>

**Biosafety Level 4** is appropriate for life-threatening hazardous agents or pathogens which may be spread through the aerosol route and has no available vaccine or therapy. Examples are Marburg or Congo-Crimean hemorrhagic fever. Hazards may be acquired through infectious aerosols, skin membrane exposure to hazardous droplets, and autoinoculation.<sup>4</sup>

To isolate the infectious agents completely, procedures should be done in Class III BSC or while in a full-body air-supplied positive-pressure personnel suit. The BSL-4 laboratory is located in an isolated complex with specialized ventilation and waste management systems.<sup>4</sup>

The entire operation of the laboratory should be handled by a laboratory director. A supplement to this will be the presence of trained laboratory personnel, safety measures/manuals, safety equipment, appropriate design of facilities, personal protective equipment, and biosafety level practices.<sup>4</sup>

## V. Laboratory Biosafety Level Criteria

Biosafety or laboratory biosafety describes the [containment principles, technologies and practices](#) that are implemented to prevent the unintentional exposure to pathogens and toxins, or their accidental release.<sup>5</sup>

In this chapter, the direction and proposals given as least prerequisites relating to labs of all biosafety levels are coordinated at microorganisms in Risk Groups 1–4. Although some of the prerequisites may seem to be excessive for several microorganisms in Risk Group 1, such preventive measures are helpful for training purposes in promoting good microbiological techniques (GMT).

### Risk Criteria for Establishing Ascending Levels of Containment

Infectivity, disease severity, transmission (form one host to another), and the nature of work being directed are the essential risk criteria used to characterize the four-ascending classification of containment, discussed as biosafety levels 1 through 4. Also, another significant factor to consider is the origin of the causative agent, whether exotic or indigenous. With this, each level of containment describes the microbiological practices, safety equipment and facility safeguards for the corresponding level of risk associated with handling a particular agent.<sup>6</sup>

Table 5.1 Summary of Laboratory Biosafety Level Criteria

BSL	Agents	Practises	Safety Equipment	Facilities
1	RG1	Standard Micro	None	Sink available
2	RG2	BSL-1 plus: <ul style="list-style-type: none"> <li>Limited access</li> <li>Biohazard signage</li> <li>Sharps precautions</li> <li>Biosafety manual</li> </ul>	<ul style="list-style-type: none"> <li>Use of BSCs for aerosol protection</li> <li>PPE-lab coats, gloves, face/eye protection</li> </ul>	BSL-1 plus: <ul style="list-style-type: none"> <li>Autoclave available</li> <li>Directional air</li> </ul>
3	RG2, 3	BSL-2 plus: <ul style="list-style-type: none"> <li>Controlled access</li> <li>Decon of all waste and linens</li> <li>Medical Surveillance</li> </ul>	<ul style="list-style-type: none"> <li>Use of BSC's for all work,</li> <li>PPE-protective clothing, gloves, respiratory protection if needed</li> </ul>	BSL-2 plus: <ul style="list-style-type: none"> <li>Physical separation</li> <li>Self-closing, double-door access</li> <li>Negative airflow</li> </ul>
4	RG4	BSL-3 plus: <ul style="list-style-type: none"> <li>Clothing change before entry</li> <li>Shower on exit</li> <li>Decon all materials on exit</li> </ul>	<ul style="list-style-type: none"> <li>Class III BSC or</li> <li>Class I or II BSC in combination with air-supplied, positive pressure personnel suit</li> </ul>	BSL-3 plus: <ul style="list-style-type: none"> <li>Isolated zone</li> <li>Dedicated supply/exhaust, vacuum, and decon system, . Etc.</li> </ul>

### A. Biosafety Level 1

- Biosafety level 1 (BSL-1) is the basic level of protection and is appropriate for agents that are not known to cause disease in normal, healthy humans.
- Standard Microbiological Practices: GMT, Good Microbiological Techniques
- Special Practices: None
- Safety Equipment: Open Bench Worktop
- Laboratories Facilities: For Basic Teaching Research Facility

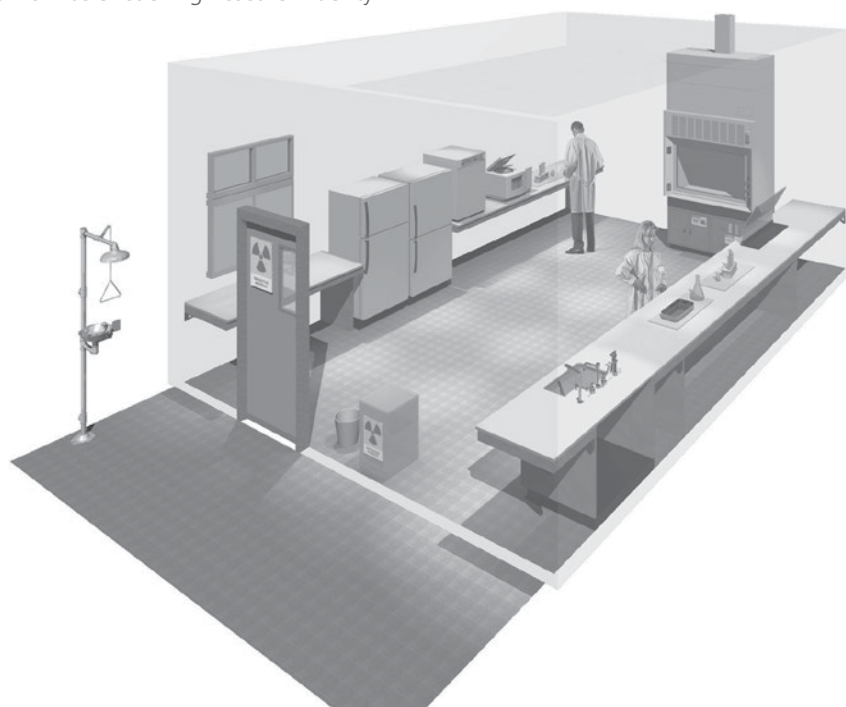

## B. Biosafety Level 2

- Biosafety level 2 (BSL-2) is appropriate for handling moderate-risk agents that cause human disease of varying severity by ingestion or through percutaneous or mucous membrane exposure.
- Standard Microbiological Practices: GMT plus protective clothing (PPE), Biohazards sign
- Special Practices: Separate bin for general waste, biohazards and sharps
- Safety Equipment: Open bench and Biosafety Cabinet for potential aerosols
- Laboratories Facilities: Primary health services, diagnostic services, research

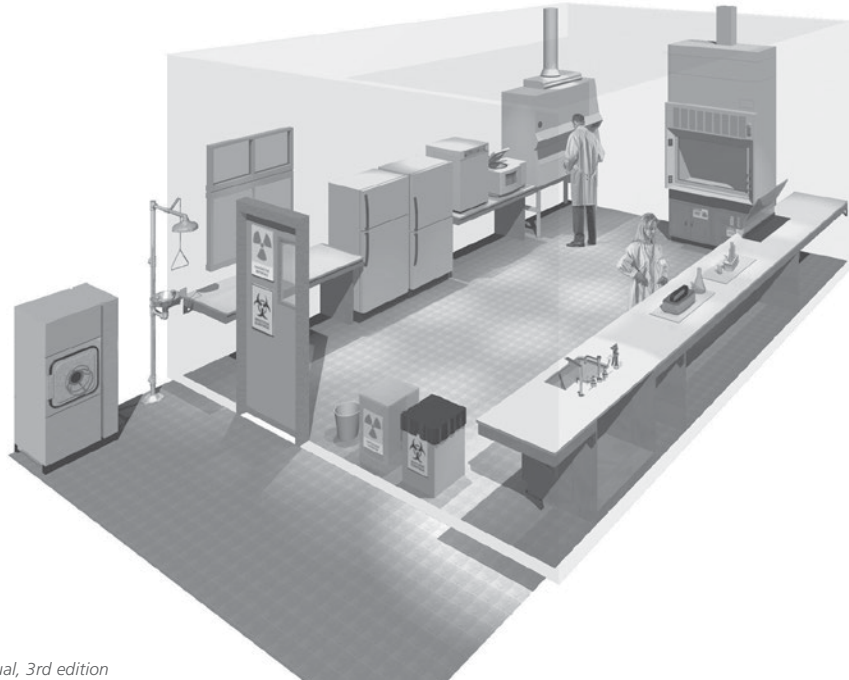

Source: WHO Laboratory Biosafety Manual, 3rd edition

## C. Biosafety Level 3

- Biosafety level 3 (BSL-3) is appropriate for agents with a known potential for aerosol transmission, for agents that may cause serious and potentially lethal infections and that are indigenous or exotic in origin.
- Standard Microbiological Practices: BSL 2 plus special clothing, controlled access, directional airflow (negative-pressure)
- Special Practices: air shower upon entry and exit of the laboratory; garment change room
- Safety Equipment: BSC and/or other primary devices for all activities
- Laboratories Facilities: Special Diagnostic Services, Research

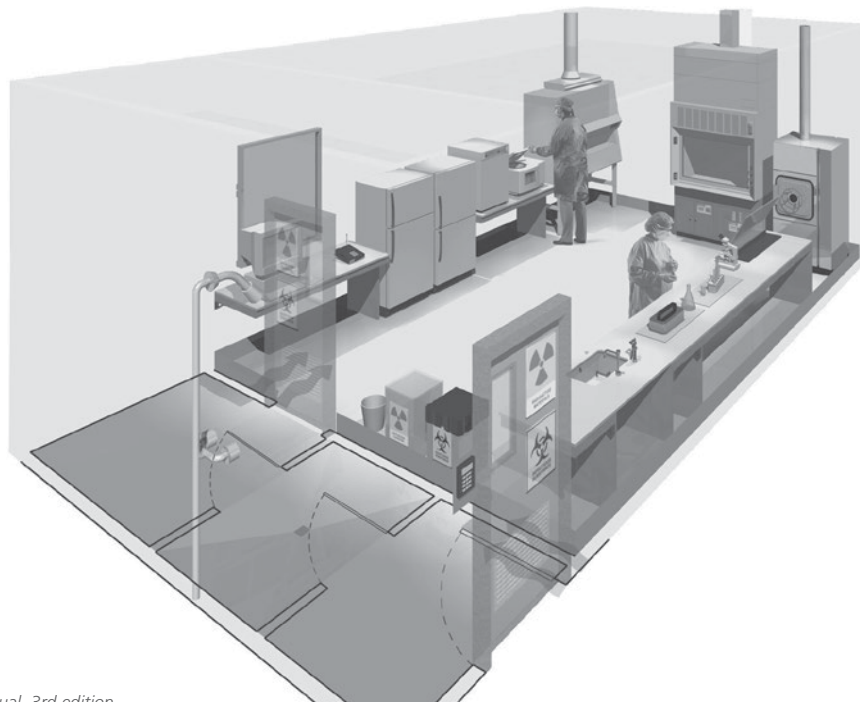

Source: WHO Laboratory Biosafety Manual, 3rd edition

## D. Biosafety Level 4

- Exotic agents that pose a high individual risk of life-threatening disease by infectious aerosols and for which no treatment is available are restricted to high containment laboratories that meet biosafety level 4 (BSL-4) standards.
- Standard Microbiological Practices: BSL 3 plus airlock entry, shower exit, special waste disposal
- Special Practices: Decontamination of all material upon entry and exit of the laboratory
- Safety Equipment: Class II BSC or positive pressure suits in conjunction with Class II BSCs, double-ended autoclave (through the wall), filtered air
- Laboratories Facilities: Dangerous pathogen units (e.g. outbreaks, incurable diseases)

Generally, in diagnostic and health-care setting (e.g. hospital-based, clinical and public health), laboratories must be at least Biosafety Level 2 or above. Also, the fact that the laboratory workers are being exposed to organisms in higher-risk groups than predicted must be recognized in safety plans and policies development. There are even countries where accreditation of clinical laboratories is required. Globally, standard biosafety precautions should always be properly implemented and followed.

The guiding principle for **basic laboratories** (Biosafety Levels 1 and 2) is detailed and comprehensively discussed as they are fundamental to laboratories of **all biosafety levels**. On the other hand, guidelines for **containment laboratories** (Biosafety Level 3) and **maximum containment laboratories** (Biosafety Level 4) indicated are alterations of and additions to the basic laboratories guidelines which are designed for applications involving more hazardous microbiological agents.



Biosafety Level 4 (BSL 4) requires the use of an air-supplied, positive pressure personnel suit.



Also called a Hazmat Suit, it has a self-contained breathing apparatus (SCBA) to ensure a supply of breathable air.



Hazmat Suit is consisting of an impermeable whole-body garment worn as protection against biohazards.



Hazmat Suit is used in BSL 4 with Class I or Class II BSC

Table 5.2 Summary of Laboratory Facility Requirements<sup>5</sup>

Facility Requirement		Biosafety Level			
		1	2	3	4
Laboratory Isolation		No	No	Yes	Yes
Room Seal for Decontamination		No	No	Yes	Yes
Ventilation	• Negative Pressure	No	Advisable	Yes	Yes
	• Controlled Ventilation System	No	Advisable	Yes	Yes
	• HEPA filter at exhaust	No	No	Yes/ No <sup>a</sup>	Yes
Double-door access		No	No	Yes	Yes
Airlock		No	No	No	Yes
Airlock with shower		No	No	No	Yes
Anteroom		No	No	Yes	--
Anteroom with shower		No	No	Yes/ No <sup>b</sup>	No
Laboratory Waste Treatment		No	No	Yes/ No <sup>b</sup>	Yes
Autoclave on Site		No	Advisable	Yes	Yes
Autoclave inside the laboratory		No	No	Advisable	Yes
Autoclave (double-ended)		No	No	Advisable	Yes
Biological Safety Cabinet		No	No	Yes	Yes
Personnel Safety Monitoring Facility <sup>c</sup>		No	No	Advisable	Yes

<sup>a</sup> Dependent on location of exhaust (see chapter 4 of WHO Biosafety Manual 3rd Edition)

<sup>b</sup> Dependent on agent(s) used in the laboratory

<sup>c</sup> For example, window, closed-circuit television, two-way communication

## VI. Biological Safety Cabinets

Biological Safety Cabinet is a primary engineering control which provides user protection against biohazards as the inflow air creates airflow barrier preventing accidental release of biohazards from the cabinet's working area and at the same time provides product protection with the airflow barrier inside the work zone which is on the other hand created by the downflow air.

Table 6.1 Classification of Biological Safety Cabinets (per NSF / ANSI Standard 49)

Class	Inflow Velocity (m/s)	Recirculating Air (%)	Exhaust Air (%)	Metal Plenum Surrounded by	Exhaust Alternatives	Biosafety Level
I **	0.38	0	100	Outside Air	Inside Room/ Hard Duct	1,2 & 3
II Type A1	0.38	70	30	Outside Air	Inside Room/ Thimble Duct	1,2 & 3 *
II Type A2 **	0.50	70	30	Negative Plenum	Inside Room/ Thimble Duct	1,2 & 3 *
II Type B1	0.50	30	70	Negative Plenum	Hard Duct only	1,2 & 3 *
II Type B2	0.50	0	100	Negative Plenum	Hard Duct only	1,2 & 3 *
III **	Closed: > 0.5" WC	0	100	Negative Plenum	Inside Room/ Hard Duct	1,2, 3 & 4

\* Open front cabinets (e.g. Class II BSC) can still be used in BSL 4 facilities but will require positive-pressured personnel suit for laboratory users.

\*\* EN 12469 only recognizes Class I, Class II and Class III BSCs; Class II BSC Inflow velocity requirement as per EN 12469:  $\geq 0.40$  m/s

## A. International Standards of Biological Safety Cabinets

Biosafety Cabinet is an equipment expected to deliver safety of the user and samples against biohazards and possible contaminants that may significantly affect one's scientific procedure. Hence, it is a necessity that the containment capability of the BSC be subjected to a series of criteria by a certain standard in which the manufacturers of such safety equipment should comply to. Globally, there is a number of standards for biosafety cabinets which could be locally or internationally required to conform to.



### About ANSI / NSF 49

The NSF International (formerly The National Sanitation Foundation) Biological Safety Cabinetry Program was initiated during the 1970s at the request of the regulatory community, including the Centers for Disease Control (CDC), National Institutes of Health (NIH), and the National Cancer Institute (NCI).

The first phase of the program was the development of NSF/ANSI Standard 49 for the evaluation of Class II laminar flow biological safety cabinets. The standard was completed in 1976, followed by the implementation of a testing and certification program to that standard, titled the Biological Safety Cabinetry Certification Program. The third and final stage was completed in 1993, titled the Biological Safety Cabinet Field Certifier Accreditation Program.

Certification program is accredited by the American National Standards Institute (ANSI) and the Standards Council of Canada (SCC), and is recognized as the leader in the certification of Class II Biological Safety Cabinets throughout the USA and Canada.



### About UL

Underwriters Laboratories Inc. (UL) is an independent, not-for-profit product-safety testing and certification organization. Founded in 1894, UL is now one of the most recognized conformity assessment providers in the world. Conformity to UL Standard 61010A-1 (Electrical Equipment for Laboratory Use; Part 1: General Requirements) is a pre-requisite to NSF certification.



### About EN 12469

EN 12469: 2000 Biotechnology - Performance criteria for microbiological safety cabinets is the new harmonized European standard for microbiological safety cabinets, published by CEN, the European Committee for Standardization. This standard replaces the following standards for Biological Safety Cabinets: British Standard BS5726, German Standard DIN12950 Teil 10 and French Standard NF X44-201:1984. The European Committee for Standardization (CEN) was founded in 1961 by the national standards bodies in the European Economic Community and EFTA countries.



### About JIS K3800

The Japan Industrial Standard (JIS) K3800 covers performance and safety requirements for Class II biological safety cabinets. Certification to JIS K3800 is performed by Japan Air Cleaning Association (JACA). Similar to NSF International, JACA also performs field certifier training and accreditation in Japan.



### About AS 2252

AS 2252 is also known as the Australian standard, was prepared by the Australian members of the Joint Standards Australia/Standards New Zealand Committee ME-060. It supersedes AS/NZS 2647:2000. This standard specifies requirements for biological safety cabinets including installation and use. For Class I biological safety cabinet, emphasis is given to personnel and environment protection. For Class II biological safety cabinet, its design should provide personnel, environment and product protection.



### About CFDA YY 0569

CFDA YY 0569, formerly known as State Food and Drug Administration YY 0569 (SFDA YY 0569) is the Chinese Standard for biological safety cabinets. It is modeled on both the EN 12469:2000 and NSF 49:2002. This standard adopted the KI-DISCUS test from the European standard. Even though YY 0569 is based from the two major international standards, there are some notable improvements, i.e. instant display for air exchange rate and air intake, audio and visual warning system, to alert workers to performance malfunctions of biological safety cabinets. It is similar to NSF such that it recognizes four types of Class II BSCs. In summary, there are aspects unique to NSF and EN standards that are used as basis for YY 0569.

## B. Class I Biological Safety Cabinet

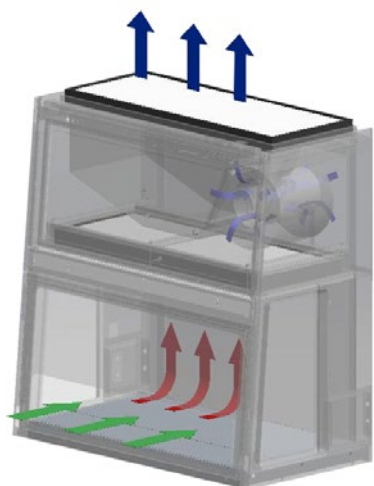

BSC Class I Airflow Diagram

### a. Class I BSC

The Class I cabinet has the most basic and rudimentary design of all biological safety cabinetry available today. A stream of inward air moving into the cabinet contains aerosols generated during microbiological manipulations. It then passes through a filtration system that traps all airborne particles and contaminants. Finally, clean and decontaminated air is exhausted from the cabinet. The filtration system usually consists of a pre-filter and a HEPA (High Efficiency Particulate Air) filter.

Although the Class I cabinet protects the operator and the environment from exposure to biohazards, it does not prevent samples being handled in the cabinet from coming into contact with airborne contaminants that may be present in room air. Naturally, there is a possibility of cross-contamination that may affect experimental consistency. Consequently, the scope and application of Class I cabinets is limited, and it is largely considered obsolete.

All Class I biological safety cabinets are suitable for work with microbiological agents assigned to biosafety levels 1, 2 and 3.<sup>9</sup>

## C. Class II Biological Safety Cabinets

### a. Class II Type A1/A2

#### Class II Type A Biological Safety Cabinet

The Class II Type A biological safety cabinet is the most common Class II cabinet. It is also the most common safety cabinet of all the different types available. It has a common plenum from which 30% of air is exhausted, and 70% re-circulated to the work area as the downflow. If trace amount of toxic chemicals is employed as an adjunct to microbiological processes, type A cabinets should be exhaust ducted. Exhaust HEPA filtration only removes airborne aerosols including biohazards, and not chemical fumes. If larger amount of vaporizing toxic chemicals is used, type B cabinets should be used instead of type A. Stated from NSF/ANSI 49:2010, both the Class II Type A1 and Type A2 must have the positively-pressurized contaminated plenum to be surrounded by negative pressure. In case there is a leakage on the positive plenum, the leaking aerosol will be pulled by the negative pressure back to the positive plenum, and it will not leak out. In the A2 cabinet, about 70% of air from the positive plenum is recirculated as downflow, and the remaining 30% is discharged to the lab through the exhaust filter.

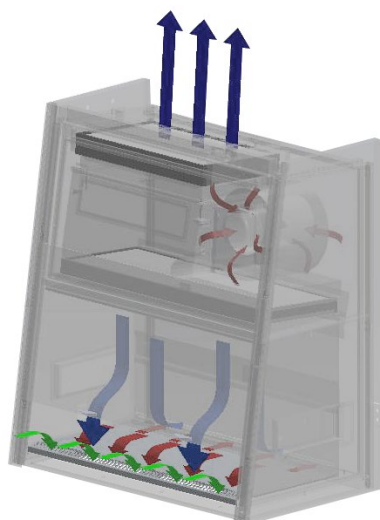

BSC Class II Type A2 Airflow Diagram

### b. Class II Type B1/B2

#### Class II Type B Biological Safety Cabinet

The main difference between Type A and Type B cabinet is: Type B cabinets must be operated with an external blower and it exhausts air to the external environment via a dedicated ductwork system. Without the external blower, the cabinet's internal blower will blow the air (and microbiological agents) inside the work zone through the front opening, towards the operator's face, creating a dangerous situation. Following NSF/ANSI 49 standard, this situation will not happen in Esco BSC as it has an interlock system which will automatically shut off the cabinet's internal blower when a loss of exhaust air volume happens. Moreover, a B2 cabinet is not self-balancing, in the sense that its own blower can only create downflow, and the cabinet relies on the external blower to create inflow.

On all Type B cabinets, environmental protection may be enhanced by installing a scrubbing system between the exhaust of the cabinet and the final exhaust point outside the building to neutralize the chemical fumes present in exhaust air. Although Type B cabinets are commonly used when chemicals are involved in your work processes, they theoretically provide an increased level of safety as compared to other Type A cabinets. By exhausting air directly to the external environment, they provide an additional "fail-safe" in the event that the regular exhaust HEPA filtration ceases to function.

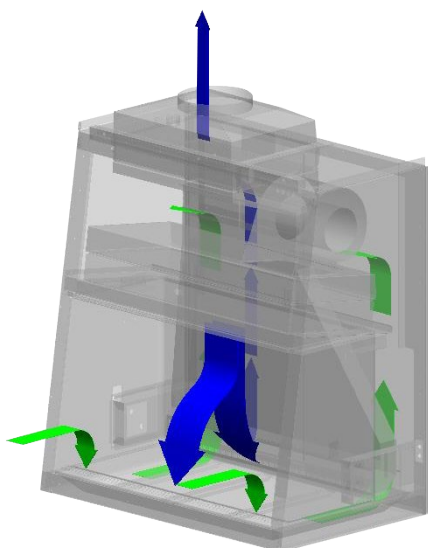

BSC Class II Type B1 Airflow Diagram



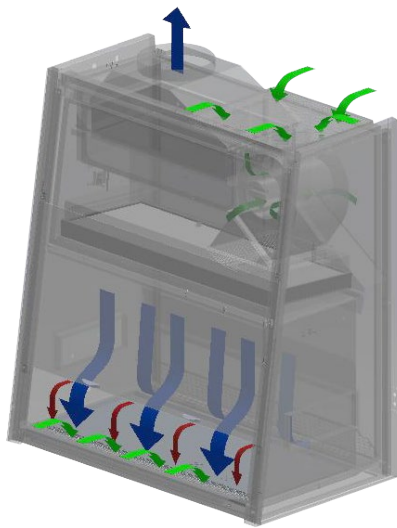

BSC Class II Type B2 Airflow Diagram

### i. Class II Type B1 Biological Safety Cabinets

The Class II Type B1 biological safety cabinet was originally specified by the American National Cancer Institute. It has a common plenum from which 70% of air is exhausted, and 30% re-circulated to the work area as the downflow.

Type B1 cabinets also have a dedicated exhaust feature that eliminates re-circulation when work is performed towards the back within the interior of the cabinet. Toxic chemicals employed as an adjunct to microbiological processes should only be employed if they do not interfere with work when re-circulated in the downflow.

### ii. Class II Type B2 Biological Safety Cabinets

Classification of Biological Safety Cabinets (per NSF / ANSI Standard 49). Type B2 cabinets are suitable for work with toxic chemicals employed as an adjunct to microbiological processes under all circumstances since no re-circulation occurs. In theory, Type B2 cabinets may be considered to be the safest of all Class II biological safety cabinets since the total exhaust feature acts as a fail-safe in the event that the downflow and / or exhaust HEPA filtration systems cease to function normally. However, Class II Type B2 cabinets are, in practice, difficult to install, balance and maintain.

## D. Class III Biological Safety Cabinet

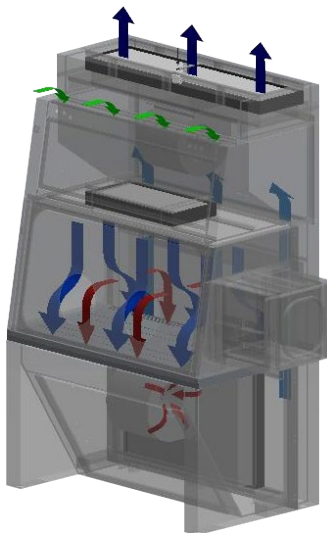

BSC Class III Airflow Diagram

The Class III biological safety cabinet provides an absolute level of safety, which cannot be attained with Class I and Class II cabinets. All Class III cabinets are usually made of welded metal construction and are designed to be gas tight. Work is performed through glove ports in the front of the cabinet. During routine operation, negative pressure relative to the ambient environment is maintained within the cabinet. This provides an additional fail-safe mechanism in case physical containment is compromised.

On all Class III cabinets, a supply of HEPA filtered air provides product protection and prevents cross contamination of samples. Exhaust air is usually HEPA filtered and incinerated. Alternatively, double HEPA filtration with two filters in series may be utilized. Materials are transferred into the cabinet using a pass-through unit installed at the side of the work area. Class III cabinets usually exhaust air back to the laboratory; however, air may also be exhausted via a dedicated ductwork system to the external environment. When a dedicated ductwork system is employed, they are also suitable for work employing toxic chemicals as an adjunct to microbiological processes.

All Class III biological safety cabinets are suitable for work with microbiological agents assigned to biosafety levels 1, 2, 3 and 4. They are frequently specified for work involving the most lethal biological hazards.

## E. Horizontal Laminar Flow “Clean Benches”

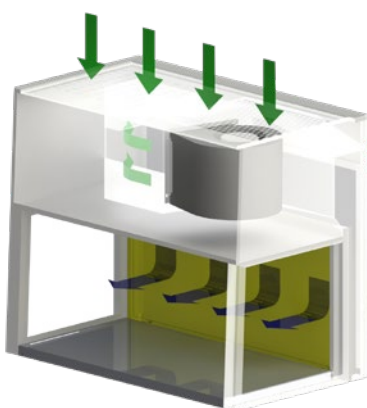

Horizontal Laminar Flow Cabinet Airflow Diagram

Laminar flow is literally defined as “uninterrupted flow in a fluid near a solid boundary in which the direction of flow at every point remains constant” (Merriam-Webster). Laminar flow clean bench keeps up a controlled work surface for applications requiring a sterile work space whereas contaminant access is being prevented by a constant airflow across the surface.

During operation, room air is drawn through the top of the clean bench through a washable pre-filter with 85% arrestance, trapping larger particles prolonging the life of the main filter.

The air is then forced evenly through the HEPA filter resulting in unidirectional stream of clean air projected vertically over the internal work zone. All airborne contaminants are flushed and diluted, resulting in particulate-free work environment.

The purified air travels across the working zone of the clean bench in a **horizontal, unidirectional** stream and leaves the main work chamber across the entire open front of the clean bench.

### Applications of Horizontal Laminar Flow Clean Bench

- Plant tissue culture
- Medical device assembly
- Media plate preparation
- Pharmacy drug preparation
- Electronics inspection

## F. Vertical Laminar Flow “Clean Benches”

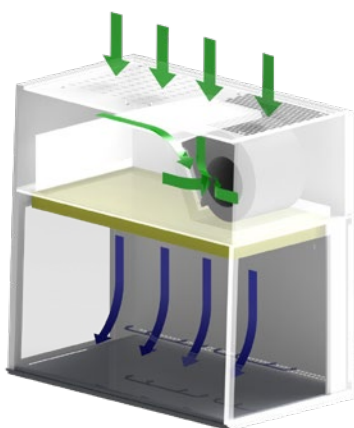

Vertical Laminar Flow Cabinet Airflow Diagram

Both types of laminar flow draws room air from the top of the clean bench through a disposable pre-filter with 85% arrestance, however, in a vertical laminar flow clean bench, the purified air travels across the working zone of the clean bench in a vertical, unidirectional stream and leaves the main work chamber across the entire open front of the clean bench and through airflow slots at the back wall of the work zone which are designed to eliminate air turbulence and the possibility of dead air corners in the work zone.

### Applications of Vertical Laminar Flow Clean Bench

- Microbiology (Non-infectious microorganisms)
- Forensics
- Biotechnology (e.g. PCR)
- Sterile product compounding

## G. Working with Chemicals in BSCs

Chemical handling standardly should be done under a fume hood. However, there are several applications that require usage of chemicals adjunct to microbiological handling which creates exemptions in prohibiting dealing with chemicals under a biosafety cabinet due to absence of hard ducting and/or carbon filter. (See Table 6.2).

Despite of providing protection limited to personnel only, Class I biosafety cabinet has the advantage of providing user and environmental protection against radionuclides and volatile toxic chemicals.<sup>5</sup>

**Class II Type B1 or Class II Type A biosafety cabinet** with thimble ducting can also be used for general microbiological handling with small amount of non-toxic and non-volatile chemicals. In an additional note, NSF 49, one of the internationally acknowledged BSC standards, requires alarm-equipped thimble ducting in Class II Type A2 BSCs. As per NSF, effective **April 15, 2016**, NSF accredited certifiers shall no longer certify either **direct-connected or canopy connected** Type A cabinets **without alarms**, even if specifically asked to do so by the customers.<sup>7</sup>

More information regarding this implementation can be accessed from this link:

[http://www.nsf.org/newsroom\\_pdf/NSF\\_Biosafety\\_Cabinet\\_Memo\\_Canopy\\_Connections.pdf](http://www.nsf.org/newsroom_pdf/NSF_Biosafety_Cabinet_Memo_Canopy_Connections.pdf)

Lastly, **Class II Type B2 biosafety cabinets** are highly preferred if dealing with larger amount of vaporizing toxic chemicals as exhaust HEPA/ULPA filtration only removes biohazard aerosols and not chemical fumes.

## H. Radiological Hazards in the BSC

Radiologically contaminated products are hazardous as these are potentially carcinogenic (can cause cancer) or even mutagenic (can cause cell mutations), whereas negative health effects normally occur in the lengthier period.<sup>11</sup> Radiological hazards also may result from unintentional release, e.g., nuclear facility accidental leakage resulting or from damage to a nuclear facility due to a natural disaster.<sup>10</sup>

Radiological (and chemical) hazards when dealt under a BSC require design adjustments in the cabinet or building exhaust system e.g. including charcoal filters because HEPA/ULPA filters do not retain vaporizing agents making evaluation of intrinsic chemicals significant in initial assessment prior to selecting a BSC. A Class II Type B2 BSC, also called a total exhaust cabinet, is necessary when significant amounts of radionuclides and volatile chemicals are expected to be used.<sup>5</sup> (See Table 6.4)

## I. Selection, Installation and Safe Use of BSCs

### a. Air Filtration Systems and the Development of Biological Containment Devices

Fundamentally, what is ‘clean air’? Clean air is a space where particle concentration in the air is controlled to the levels appropriate for working on contamination-sensitive applications. Clean air products are usually used for the following applications: micro-electronics/semiconductors, optical manufacturing, nuclear & aerospace, pharmaceuticals, life sciences & laboratory, food processing, security (e.g. anthrax mail).

In airflow containment equipment, work zone cleanliness is determined according to its ISO classification. In ISO 14644-1, air cleanliness shall be designated by an ISO number whereas the maximum allowed particle concentration for each considered particle size is determined from Table 6.2.

Table 6.2 ISO Classes of air cleanliness by particle concentration (ISO 14644-1: 2015)

ISO Class Number	Maximum allowable concentration (particles/m <sup>3</sup> ) for particles equal to and greater than the considered sizes, shown below <sup>a</sup>					
	0,1 µm	0,2 µm	0,3 µm	0,5 µm	1 µm	5 µm
1	10	2	d	d	d	e
2	100	24 <sup>b</sup>	10	4	d	e
3	1 000	237	102	35 <sup>b</sup>	8	e
4	10 000	2 370	1 020	352	83 <sup>b</sup>	e
5	100 000	23 700	10 020	3 520	832	29
6	1 000 000	237 000	102 000	35 200	8 320	293
7	c	c	c	352 000	83 200	2 930
8	c	c	c	3 520 000	832 000	29 300
9 <sup>g</sup>	c	c	c	35 200 000	8 320 000	293 000

<sup>a</sup> All concentrations in the table are cumulative, e.g. for ISO Class 5, the 10 200 particles shown at 0,3 µm include all particles equal to or greater than this size

<sup>b</sup> These concentrations will lead to large air sample volumes for classification. Sequential sampling procedure may be applied; see Annex D of ISO 14644-1: 2015

<sup>c</sup> Concentration limits are not applicable in this region of the table due to very high particle concentration

<sup>d</sup> Sampling and statistical limitations for particles in low concentrations make classification inappropriate

<sup>e</sup> Sample collection limitations for both particles in low concentrations and sizes greater than 1 µm make classification at this particle size inappropriate, due to potential particle losses in the sampling system

<sup>f</sup> In order to specify this particle size in association with ISO Class 5, the macroparticle descriptor M may be adapted and used in conjunction with at least one other particle size.

<sup>g</sup> This class is only applicable for the in-operation state.

Table 6.3 Applications with work zone ISO Class requirement

ISO Class	Application
3 / 4	Sensitive semiconductor or pharmaceutical work
5	Laminar flow cabinets, biological safety cabinets, pharmaceutical isolators
7	Clean room for pharmaceutical preparation, used with laminar flow or biosafety cabinets inside
8	Typical hospital environment
9	Typical office or labs without air filtering

## b. Selection of a Safety Cabinet through Risk Assessment

A BSC should be selected primarily according to the type of protection required: product protection; personnel protection against Risk Group 1–4 microorganisms; personnel protection against exposure to radionuclides and volatile toxic chemicals; or a combination of these. Table 6.4 shows which BSCs are recommended depending on the necessary type of protection.

Table 6.4 Selection of a Safety Cabinet through Risk Assessment<sup>f</sup>

Type of Protection	BSC Selection
Personnel Protection against RG 1-3 microorganisms	Class I, Class II, Class III BSC
Personnel protection against RG 4 microorganisms, glove-box laboratory	Class III BSC
Personnel protection against RG 4 microorganisms, suit laboratory	Class I, Class II BSC
Product Protection	Class II, Class III BSC only if laminar flow included
Volatile radionuclide/chemical protection (small amount)	Class II Type B1, Class II Type A2 (with thimble ducting) BSC
Volatile radionuclide/chemical protection	Class I, Class II Type B2, Class III BSC

### c. Installation

#### i. Secondary Barriers (Facility Design)

While biological safety cabinets are viewed as the primary safety barrier for control of infectious materials, the research facility/laboratory room itself is viewed as a secondary safety barrier. Inward directional air is built up by greater volume of air than is provided to a given research facility/laboratory room and by drawing air from the adjacent space. This is optional at biosafety level 2 yet should be kept up at BSL-3. The air balance for the entire facility ought to be built up and kept up to ensure that air flow is from areas of least-to more contamination.<sup>6</sup>

#### ii. Building Exhaust

Due to the contaminated air coming from BSL-3 and BSL-4, exhaust laboratory air must be directly exhausted. This idea is alluded to as a dedicated single-pass exhaust system. The exhausted room air can be HEPA-filtered when an excessive level of aerosol containment is required, which is continually actual at BSL-4 and is non-compulsory at BSL-3. At the point when the building exhaust system is utilized to vent a ducted BSC, the system must have an ample capacity to maintain the exhaust flow if changes in the static pressure inside the system should occur. Otherwise, each BSC must have a dedicated exhaust system.<sup>6</sup>

Before installation of BSC which requires a connection to building exhaust system, a facility engineer should be consulted first to ensure that an adequate supply air must be given in providing the appropriate function of the exhaust system. Right angle bends, long horizontal runs, and transitional connectors within the systems will be included in the demand on the exhaust fan. The building exhaust air ought to be released far from supply air intakes, to prevent entrainment of exhausted laboratory air back into the building air supply system.<sup>6</sup>

#### iii. Utility Services

Utility services such as electrical outlets and vacuum system within the BSC must be planned carefully. Vacuum system must be protected accordingly. Electrical outlets within the cabinet must be protected by ground fault circuit interrupters and should be supplied by an independent circuit. When propane or natural gas is provided, a clearly marked emergency gas shut-off valve outside the cabinet must be installed for fire safety. All non-electrical utility services should have exposed, accessible shut-off valves. The utilization of compressed air inside a BSC must be deliberately considered and controlled to avoid aerosol generation and lessen the potential for vessel pressurization.<sup>5</sup>

#### iv. Ultraviolet Lights

Ultraviolet lights are not required in BSCs. If they are used, they must be cleaned weekly to remove any dust and dirt that may block the germicidal effectiveness of the light. Ultraviolet light intensity should be checked when the cabinet is recertified to ensure that light emission is appropriate. Ultraviolet lights must be turned off while the room is occupied, to protect eyes and skin from inadvertent exposure. Ultraviolet lights are not a substitute for routine surface decontamination on the BSC work area.<sup>7</sup>

#### v. BSC Placement (As per NSF/ANSI 49 - 2016)



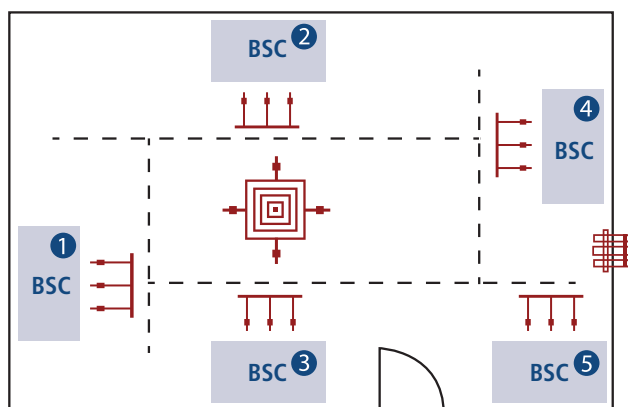

The velocity of air flowing through the front opening into a BSC is about 0.45 – 0.53 m/s.

At this velocity, the integrity of the directional air inflow is fragile and can be easily disrupted by air currents generated by people walking close to the BSC, open windows, air supply registers, and opening and shutting doors.

Ideally, BSCs should be situated in a location remote from traffic and potentially disturbing air currents. Whenever possible a 30 cm clearance should be provided behind and on each side of the cabinet to allow easy access for maintenance. A clearance of 30~35 cm above the cabinet may be required to provide for accurate air velocity measurement across the exhaust filter and for exhaust filter changes.<sup>7</sup>



1. Cabinet 1 is quite appropriately located with respect to avoidance of excessive air movements from surrounding areas.
2. The airflow of cabinet 3 could also be influenced by the air inlet.
3. Cabinet 2 is too close to the doorway and its airflow could be influenced by the air inlet too.
4. Cabinet 5 is suitably located provided that the adjacent return air grille does not influence cabinet airflow
5. Cabinet 4 is too close to the doorway..

	Biological Safety Cabinet		Barrier Airflow
	Return Air Grille		Air Inlet
	Personnel Traffic		

*Table 6.5 Illustrates various possible influences by a room's design and ventilation system*

Placement Recommendation
<p>BSCs not connected to an exhaust system should have at least [12 inches (300 mm)] clearance from the filter face and any overhead obstructions when the cabinet is in its final operating position, to allow for testing of the Exhaust HEPA/ULPA filter. At least 12 inches (300 mm) clearance is required if the use of a thermal anemometer exhaust velocity measurement is needed when calculating cabinet inflow velocity.</p>
<p>All BSCs should be placed in a laboratory at a location that provides a minimum of:</p> <ul style="list-style-type: none"> <li>• 6 inches (150 mm) from adjacent walls or columns.</li> <li>• 6 inches (150 mm) between two BSCs.</li> <li>• 6 inches (150 mm) space between both sides of the cabinet and 6 inches (150 mm) behind the BSC to allow for service operations.</li> <li>• 40 inches (1020 mm) of open space in front of the BSC</li> <li>• 60 inches (1520 mm) from opposing walls, bench tops and areas of occasional traffic.</li> <li>• 20 inches (510 mm) between BSC and bench tops along a perpendicular wall.</li> <li>• 100 inches (2540 mm) between two BSCs facing each other.</li> <li>• 60 inches (1520 mm) from behind a doorway.</li> <li>• 40 inches (1020 mm) from an adjacent doorway swing side.</li> <li>• 6 inches (150 mm) from an adjacent doorway hinge side.</li> </ul>

#### **d. Safe Use of BSCs**

##### **i. Start-up<sup>7</sup>**

- Wear gloves for hand protection
- Surface decontaminate and load all required materials to be placed inside the cabinet prior to starting the work
- Surface decontaminate the work surface, side walls and inner back walls
- Allow the work zone air to purge for a few minutes before commencing work
- Do not overcrowd the work zone
- Close the drain valve before operation

##### **ii. Material Placement inside the BSC**

The front intake grill of Class II BSCs must not be blocked with paper, equipment or other items. Materials to be placed inside the cabinet should be surface-decontaminated with 70% alcohol. Work may be performed on disinfectant-soaked absorbent towels to capture splatters and splashes. All materials should be placed as far back in the cabinet, towards the rear edge of the work surface, as practical without blocking the rear grill. Aerosol-generating equipment (e.g. mixers, centrifuges, etc.) should be placed towards the rear of the cabinet. Bulky items, such as biohazard bags, discard pipette trays and suction collection flasks should be placed to one side of the interior of the cabinet. Active work should flow from clean to contaminated areas across the work surface.<sup>7</sup>

The autoclavable biohazard collection bag and pipette collection tray should not be placed outside the cabinet. The frequent in-and-out movement needed to use these containers is disruptive to the integrity of the cabinet's air barrier and can compromise both personnel and product protection.<sup>7</sup>

##### **iii. Operations within a BSC<sup>7</sup>**

- Do not obstruct the front or back air grilles
- Work as far into the cabinet as possible
- Minimize arm movement; make slow movements to avoid disrupting cabinet airflow
- When removing arms from cabinet be sure to surface decontaminate first, and move arms slowly out of the cabinet (in direction perpendicular to plane of work zone opening)
- Minimize external airflow disturbances
- Work from "clean to dirty"
- Biohazard collection bags should be placed inside the cabinet instead of outside
- Use absorbent pads on the work surface where appropriate to minimize splatter and aerosol generation in case of a spillage
- Surface decontaminate before removing potentially contaminated items from the interior
- Place aerosol-generating instruments as far into the interior of the cabinet as possible
- Clean materials should be at least 150 mm away from aerosol generating objects to minimize the chance for cross contamination
- Hold lids / covers above dishes / sample plates in order to prevent impingement of downward air

- Do not use a gas flame whenever possible as it interferes with airflow
- Put air turbulence generating equipment such as centrifuge, blender, or sonicator in the back 1/3 of the cabinet.

#### iv. Decontamination

##### 1. Cabinet Surface Decontamination

All items within BSCs, including equipment, should be surface-decontaminated and removed from the cabinet when work is completed, since residual culture media may provide an opportunity for microbial growth. The interior surfaces of BSCs should be decontaminated before and after each use. The work surfaces and interior walls should be wiped with a disinfectant that will kill any microorganisms that might be found inside the cabinet. At the end of the work day, the final surface decontamination should include a wipe-down of the work surface, the sides, back and interior of the glass. A solution of bleach or 70% alcohol should be used where effective for target organisms. A second wiping with sterile water is needed when a corrosive disinfectant, such as bleach, is used. It is recommended that the cabinet be left running. If not, it should be run for 5 min in order to purge the atmosphere inside before it is switched off.<sup>7</sup>

##### 2. Gas Decontamination

BSCs must be decontaminated before accessing the plenum such as in the case of blower and filter change and before being moved. The most common decontamination method is by fumigation with formaldehyde gas. In some European countries where formaldehyde is banned, decontamination can be done using chlorine dioxide or hydrogen peroxide. BSC decontamination should be performed by a qualified professional.

#### v. Bunsen Burner

Burners can cause an outflow of air from inside the cabinet that can endanger the operator. On Class II cabinets, protection against cross contamination may also be compromised. There have been incidents where the sash of a recirculating Class II safety cabinet was closed while the burner was still on, causing heat buildup in the cabinet that damaged the filters.<sup>7</sup>

Bunsen Burner Safety:

- An electronic burner which automatically reduces the gas supply to maintain a smaller flame during periods of non-use
- An emergency shut off valve should be easily accessible near to the cabinet in case of an emergency.
- The burner should be placed as far into the cabinet working space as possible to minimize its effect on cabinet performance.
- A solenoid valve can be interlocked with the gas supply to automatically shut off the burner<sup>7</sup>

#### vi. Shut Down

- Seal biohazard bags if used
- Surface decontaminate the cabinet inner sidewalls, back wall, work surface, drain pan and the inner side of the sliding sash / hinged window
- Allow work zone air to purge
- When available: install front closure or close sash and activate UV lamp (if desired)<sup>7</sup>

### e. Certifications of BSC

#### i. Development of Containment Standards

The most widely used standards in the world for Biological Safety Cabinet are the American standard ANSI/NSF 49 and European standard EN 12469 which both sets series of performance tests a biosafety cabinet must undergo.

Both the EN12469 and NSF49 are performance-based standards. The manufacturer is allowed a large degree of freedom in determining the design of their cabinet, as long as it meets the performance test criteria.<sup>14</sup>

The EN12469 is relevant to Class I, Class II and Class III biological safety cabinets whereas NSF49 only applies to Class II safety cabinets. The difference between the two standards is that NSF49 recognizes various Class II cabinet subtypes (Class II Type A1, Class II Type A2, Class II Type B1 and Class II Type B2) whereas the EN12469 defines only a general Class II cabinet.<sup>14</sup>

##### 1. NSF International Standard / American National Standard (NSF/ANSI 49)

A federal standard was created to validate air cleanliness classes and methods in observing clean workstations and clean rooms where airborne particulates are controlled by HEPA filters. The principal "standard" to be developed generally for BSCs regarded as a Federal procurement specification for biological safety cabinet of the NIH Class II, Type 1 (presently known as Type A), which had a fixed or pivoted front window or vertical sliding sash, vertical downward laminar airflow and HEPA - filtered air supply and exhaust. This guideline determined design criteria and characterized model tests for microbiological aerosol challenge, velocity profiles, and HEPA filter leak testing.<sup>6</sup>

The National Sanitation Foundation (NSF International) Standard No. 49 which applies to Class II (Laminar Flow) Biohazard Cabinetry was first published in 1976<sup>6</sup>, designed to limit risk in work with agents assigned to biosafety levels 1, 2, 3, or 4<sup>12</sup>.

This first independent standard provides basic requirements for the design, construction and performance of biosafety cabinets that are accepted in the United States designed to provide protection for personnel, products and the environment ; reliable operation ; durability and structural stability ; cleanliness ; noise level limitations ; lighting ; vibration ; and motor / blower performance.<sup>12</sup> Installation of cabinet to be evaluated under the current version of the Standard which meet and are certified by the NSF contained an NSF 49 seal.<sup>6,12</sup>

Although the NSF standard does not cover BSC field testing, many of its test methods and parameters are significantly applied in the field, and these are included in the standard's Annex "F." Recently revised in 1992 (with a new revision due in 2000), a steering board of trustees routinely review this standard to ensure that it remains constant with the advancement of technologies.<sup>6</sup>

To ensure proper operation, each cabinet should be field tested upon installation and at least annually. Furthermore, recertification should be carried out whenever changes are made to HEPA / ULPA filters, maintenance repairs are made to internal parts, or a cabinet is relocated. For hazardous or basic applications, more frequent recertification should be considered. When the cabinet meets all field test criteria, it is standard for the person conducting the assigned tests to attach a certificate of satisfactory performance to the cabinet.<sup>12</sup>

## 2. European Standard (EN 12469: 2000 Biotechnology)

EN 12496 indicates basic safety and cleanliness requirements for Biological Safety Cabinets. This standard was approved by CEN (European Committee for Standardization) on 3 January 2000, replacing the following standards for Biological Safety Cabinets: British Standard BS5726, German Standard DIN12950 Teil 10 and French Standard NF X44-201:1984.<sup>13</sup>

This European standard sets the minimum performance criteria for Safety Cabinets for work with microorganisms and indicates test methodology for BCSs for protection of the worker and the environment, product protection and cross contamination. Mechanical, electrical, chemical or radioactive safety precautions are covered by EN 61010 - 1, EN 292 - 1 and EN 292 - 2 and are not covered by the standard.<sup>13</sup>

This European Standard does not cover safety precautions for aspects that are not related to the use of microorganisms such as those that cover mechanical and electrical hazards covered by EN 61010 - 1, nor does it cover safety requirements for flammable gas and inert gas.<sup>13</sup>

### ii. Performance Testing BSCs in the Field

All Biological Safety Cabinets are to be verified to the current NSF/ANSI Standard 49, Annex F or EN12469:2000 upon installation and annually thereafter. The purpose and acceptance level of the operational tests ensure the equalization of inflow and exhaust air, the circulation of air onto the work surface, and the integrity of the cabinet and the filters. Other tests monitor the BSCs electrical and physical features.<sup>6</sup>

**1. Downflow Velocity Test:** This test determines the velocity of air traveling through the cabinet workspace.<sup>6</sup> The EN12469 indicates a permissible downflow velocity range of 0.25-0.50m/s, whereas the NSF49 does not specify any downflow velocity requirement. A Thermo-anemometer shall be used to carry out the test in accordance with NSF49 while the EN12468 does not specify the test instrument accuracy and type.<sup>14</sup>

**2. Inflow Velocity Test:** This test determines the average speed of air entering the cabinet.<sup>6</sup> To carry out the test, direct inflow measurement (DIM) instrument shall be used to measure the inlet volumetric flow rate on the front aperture at nominal operating speed (primary method) and Thermal anemometers or pitot tubes or both shall be used to verify the calculated inflow velocity (secondary method) in accordance to NSF49. The European method for measuring the rate of inflow is performed above the exhaust filter. Both EN12469 and NSF49 specify minimum requirements for inflow velocity. For Class II Type A2 cabinets, the NSF49 specifies a minimum inflow rate of 0.5 m/s, whereas the European Standard requires 0.4 m/s for Class II cabinets.<sup>14</sup>

**3. Airflow Smoke Pattern Test:** This test determines (a) whether the movement of the air along the entire perimeter of the work access opening is inward (b) whether the movement of the air within the working area is downward with no dead spots or refluxing (c) whether ambient air flows onto or over the work surface (d) whether airflow within the cabinet does not escape outside at the sides and top of the sash.<sup>6</sup> A suitable smoke generator shall be used to visualize the cabinet's airflow pattern.



Downflow Velocity Test



Inflow Velocity Test



Smoke Pattern Test

4. **HEPA/ULPA Filter Leak Test:** This test determines the integrity of supply and exhaust HEPA filters, filter housing and filter mounting frames.<sup>6</sup> To carry out the test, an aerosol generator shall be used to evenly distribute the aerosol throughout the supply (positive) cabinet plenum and an aerosol photometer shall be used to monitor aerosol penetration downstream of the filter, and to scan for the presence of leaks in accordance to NSF49. The European Standard allows an alternative test using the natural challenge test.<sup>14</sup>

5. **Light Intensity Test:** This test determines the intensity of light on the work surface of the cabinet.<sup>6</sup> A light intensity meter is used to obtain light levels at the cabinet work surface. NSF49 allows a slightly lower lighting level of 650 lux whereas the EN standard requires 750 lux.<sup>14</sup>

6. **Noise Level Test:** This test determines the noise levels produced by the cabinets.<sup>6</sup> With the cabinet running under regular parameters, a calibrated noise level meter shall be used to obtain a noise level of the cabinet during normal operation. The EN12469 test method specifies a distance further away from the cabinet as compared to the NSF49. The EN12469 allows up to 65dBa whereas the NSF49 allows up to of 67dBa.<sup>14</sup>

7. **Vibration Test:** This test determines the amount of vibration in an operating cabinet.<sup>6</sup> Vibration testing meter shall be used to verify the vibration level at the work tray.

8. **UV Radiation Intensity Test:** This test determines the energy output of the UV lamp's sufficiency in killing the microorganisms within the cabinet's work zone. 70% ethanol shall be used to clean the surface of the bulb prior to performing the test.<sup>6</sup> To carry out the test, UV radiation intensity meter shall be used to obtain light intensity at work surface level within the cabinet. UV Radiation intensity inside the cabinet should not be less than 40  $\mu\text{W}/\text{cm}^2$  at 254 nanometers (nm).<sup>14a</sup>

9. **Containment Test using KI Discus Method:** The KI (potassium iodide) discus test is defined in the European Standard for microbiological safety cabinets, EN12469:2000, as a test method for validating the operator protection capabilities of the cabinet. The KI Discus test has been designed to enable operator protection factors to be measured for class I and Class II open-fronted biological safety cabinets. Unlike test methods employing a microbiological aerosol challenge this technique enables cabinets to be evaluated without the risk of microbial contamination of either the biological safety cabinet or the laboratory.

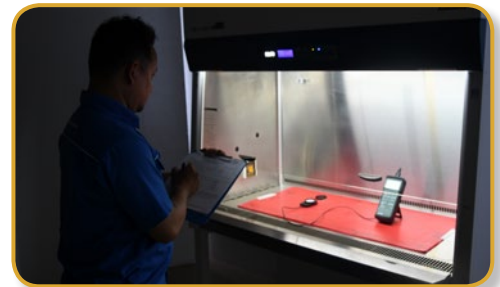

Light Intensity Test



Noise Level Test



Smoke Pattern Test



UV Radiation Intensity Test



KI Discus Test

## VII. Good Microbiological Techniques

### A. Laboratory Techniques<sup>15</sup>

#### a. Proper Handling of Speciment

- i. Container - Glass or preferably plastic container may be used for specimen collection. Ensure that the cover/cap/stopper does not permit leakage when it is applied correctly. Make sure to properly label your specimens for convenient identification and avoid wrapping specimen forms around the body of the container, rather secure it in a waterproof envelope.
- ii. Transport within the facility – Secondary containers e.g. boxes with fitted racks should be used to avoid accidental leakage or spillage. It should be decontaminated regularly through autoclaving or disinfection using disinfectants.
- iii. Receiving – There should be a designated receiving area/room for large numbers of specimens.
- iv. Unpacking of specimen – A trained personnel must open containers in a biosafety cabinet to avoid potential health hazards. Disinfectants must be available.

#### b. Proper use of pipette and pipetting aids

- i. Do not pipette by mouth.
- ii. Use cotton plugs to avoid contamination of pipettes.



- iii. Do not blow air through a liquid containing infectious agents.
- iv. To avoid mixing, do not alternately suck and expulse different infectious materials through a pipette.
- v. Do not forcibly expel liquids from pipettes.
- vi. Mark-to-mark pipettes do not require expulsion of the last drop; thus, it is preferable.
- vii. Disinfect contaminated pipette by completely submerging in an appropriate disinfectant.
- viii. Place discard container for pipette inside the biosafety cabinet.
- ix. Do not use syringes with hypodermic needles for pipetting.
- x. Place an absorbent material on the working area to avoid spread of infectious waste. Dispose the material as infectious waste after use.

#### c. Avoiding the dispersal of infectious materials

- i. Transfer loops' diameter should be 2-3mm and completely closed to avoid shedding. Also, the stem of the loop should not be more than 6 cm to reduce vibration.
- ii. Use enclosed microincinerator in sterilizing transfer loops.
- iii. When drying sputum samples, take extra precaution.
- iv. Secure discarded specimens and cultures in a leakproof container before autoclaving and/or disposal.
- v. Decontaminate the work area using the appropriate disinfectant before and after work interval.

#### d. Avoiding ingestion of infectious materials and contact with skin and eyes

- i. Use gloves during microbiological manipulations and do not touch your eyes, nose and mouth.
- ii. Do not eat, drink nor store food in the laboratory.
- iii. Do not place articles in your mouth – pens, pencils, gums – in the laboratory.
- iv. Do not apply cosmetics in the laboratory.
- v. Wear complete personal protective equipment (PPE) when working with infectious materials

#### e. Avoiding injection and infectious materials

- i. Take extra precaution in handling glassware to avoid injury resulting from broken or chipped glass. When possible, replace glassware with plasticware.
- ii. Minimize use of syringes and needles.
- iii. Don't recap needles. Discard into a puncture-proof container with cover.

#### f. Separation of serum

- i. Only trained staff should do the work.
- ii. Wear gloves and eye-protection.
- iii. Pipette blood serum carefully and do not pour.
- iv. Disinfect pipettes used.
- v. Secure discarded specimens and cultures in a leakproof container before autoclaving and/or disposal.
- vi. Clean spills and splashes using appropriate disinfectant.

#### g. Using centrifuge

- i. Operate centrifuge as per manufacturer's instruction.
- ii. Place centrifuge at a level where operators can see into the bowl to place trunnions and buckets correctly.
- iii. Inspect specimen containers for defect before use.
- iv. Securely cap tubes and specimens for centrifugation.
- v. Load, equilibrate, seal and open buckets in a biosafety cabinet.
- vi. Use only distilled water or alcohol (propanol, 70%) to balance empty buckets to avoid metal corrosion.
- vii. Use sealable centrifuge buckets for Risk Groups 3 and 4 microorganisms.
- viii. Inspect centrifuge bowl for staining and soiling and rotors and buckets for corrosion and cracks. Once present, re-evaluate protocols.
- ix. Decontaminate rotors, buckets and centrifuge bowl after use. Store bucket in inverted position.

#### h. Use of homogenizers, shakers, blenders and sonicators

- i. Do not use domestic homogenizers. Use laboratory blenders and stomachers to avoid leaks and contain aerosols.
- ii. In homogenizers, shakers, and sonicators, use polytetrafluoroethylene (PTFE) vessels instead of glass to avoid glass shattering once there is pressure build up in the vessel. These equipment should be covered by strong plastic casings and must be disinfected after use.
- iii. It is advised to operate these equipment in a biosafety cabinet.
- iv. Use hearing protection when operating sonicators.

#### i. Use of tissue grinders

- i. Operate tissue grinder in a biosafety cabinet. Plastic (PTFE) grinders are more advisable since it is safer.

#### j. Care and use of cold storage

- i. Refrigerators and freezers should be defrosted, cleaned and disinfected routinely.
- ii. Properly label all containers; name, date stored, personnel in-charge.
- iii. Do periodic inventory of the contents.
- iv. Do not store flammable solutions inside a cold storage unless it is specified as explosion proof.

#### k. Opening of ampoules containing lyophilized infectious materials

- i. Take precaution when opening ampoules of lyophilized materials since contents may be under reduced pressure and sudden inrush of air may dispense some of the materials into the atmosphere. Open ampoules inside a biosafety cabinet.
- ii. First, decontaminate the outer surface of the ampoule then file mark on the tube near to the middle of the cotton or cellulose plug, if present.
- iii. Hold the ampoule in alcohol-soaked cotton to protect hands before breaking it at file scratch.
- iv. Gently remove the top and treat it as a contaminated material.
- v. Use sterile forceps to remove the plug if it is still above the contents.
- vi. Slowly and gradually add liquid resuspension to the ampoule to avoid frothing.

#### l. Storage of ampoules containing infectious materials

- i. Do not immerse ampoules containing infectious materials into liquid nitrogen, it may cause breakage or explosion upon removal. Store ampoules in gaseous phase above the liquid nitrogen should low-temperature be required, if not, deep-freezer or dry ice would be sustainable.
- ii. Laboratory workers must be equipped with eye and hand protection in removing ampoules from storage.

#### m. Standard precautions with blood and other body fluids, tissues and excreta

- i. Collection, labelling and transport of specimens
  1. Wear gloves in conducting all procedures.
  2. Only trained staff should collect blood from patients and animals.
  3. For phlebotomies, use single-use safety vacuum devices that allow the collection of blood directly into stoppered transport and/or culture tubes, automatically disabling the needle after use.
  4. Place tubes in an appropriate container. Place request forms in a different waterproof bag or envelope.
  5. Receptionists should not open this bag.
- ii. Opening specimen tubes and sampling contents
  1. Specimen tubes should be opened in a biosafety cabinet.
  2. Wear PPE.
  3. Use a gauze or a piece of paper to grasp the stopper to prevent splashing.
- iii. Glass and "sharps"
  1. If possible, use plastic instead of glass. Only laboratory grade glass should be used. Discard chipped or cracked glasses.
  2. Do not use needles as pipettes.
- iv. Films and smears for microscopy
  1. Heat-fixing and staining do not kill microorganisms on the smear. Use sterile forceps in handling sputum, blood and fecal smears.

## B. Contingency Plans and Emergency Procedures<sup>15</sup>

Every facility working with Risk Group 3 and 4 microorganisms need a written contingency plan developed together with the national and/or local health authorities.

### a. Contingency Plan

- i. The contingency plan should give operational procedures for:
  1. Precautions against natural disasters, e.g. fire, flood, earthquake and explosion
  2. Biohazard risk assessment
  3. Incident-exposure management and decontamination
  4. Emergency evacuation of people and animals from the premises
  5. Emergency medical treatment of exposed and injured persons
  6. Medical surveillance of exposed persons
  7. Clinical management of exposed persons

8. Epidemiological investigation
9. Post-incident continuation of operations.

ii. In the development of this plan the following items should be considered for inclusion:

1. Identification of high-risk organisms
2. Location of high-risk areas, e.g. laboratories, storage areas, animal facilities
3. Identification of at-risk personnel and populations
4. Identification of responsible personnel and their duties, e.g. biosafety officer, safety personnel, local health authority, clinicians, microbiologists, veterinarians, epidemiologists, and fire and police services
5. Lists of treatment and isolation facilities that can receive exposed or infected persons
6. Transport of exposed or infected persons
7. Lists of sources of immune serum, vaccines, drugs, special equipment and supplies
8. Provision of emergency equipment, e.g. protective clothing, disinfectants, chemical and biological spill kits, decontamination equipment and supplies.

#### b. Emergency procedures for microbiological laboratories

i. Puncture wounds, cuts and abrasions

1. Affected individual should immediately remove PPE, wash hand and the infected area, apply skin disinfectant and seek medical attention as necessary. Report history of wound and microorganisms involved.

ii. Ingestion of potentially infectious material

1. Affected individual should immediately remove PPE and seek medical attention. Report identification of the ingested material and how the incident happened.

iii. Potentially infectious aerosol release (outside a biological safety cabinet)

1. Affected area must be immediately vacated, exposed personnel should seek medical attention and inform laboratory supervisor and biosafety officer. Give ample time for aerosols to exhaust and heavy particles to settle; entry must be restricted within that time. Post up signs indicating restricted entry. After the allotted time, decontamination must be carried out by trained personnel with supervision of the biosafety officer.

iv. Broken containers and spilled infectious substances

1. In case there is a contaminated broken container or spillage of infectious substance, cover it with a cloth or paper towel, then pour over appropriate disinfectant and leave it for an appropriate amount of time. After which, items may be cleared away; use forceps in handling glass fragments.

v. Fire and natural disasters

1. Fire service must be involved in the development of emergency preparedness plans. Local and national service must be informed of potential hazards within and/or near laboratory facilities, after a natural disaster. They should enter only when accompanied by a trained laboratory worker. During collection of infectious, place them in leakproof boxes or durable disposable bag. Final disposal should be determined by biosafety staff based on local ordinances.

vi. Emergency services: whom to contact

The telephone numbers and addresses of the following should be prominently displayed in the facility:

1. The institution or laboratory itself (the address and location may not be known in detail by the caller or the services called)
2. Director of the institution or laboratory
3. Laboratory supervisor
4. Biosafety officer
5. Fire services
6. Hospitals/ambulance services/medical staff (names of individual clinics, departments, and/or medical staff, if possible)
7. Police
8. Medical officer
9. Responsible technician
10. Water, gas and electricity services

## vii. Emergency equipment

The following emergency equipment must be available:

1. First-aid kit, including universal and special antidotes
2. Appropriate fire extinguishers, fire blankets

The following are also suggested but may be varied according to local circumstances:

3. Full protective clothing (one-piece coveralls, gloves and head covering – for incidents involving microorganisms in Risk Groups 3 and 4)
4. Full-face respirators with appropriate chemical and particulate filter canisters
5. Room disinfection apparatus, e.g. sprays and formaldehyde vaporizers
6. Stretcher
7. Tools, e.g. hammers, axes, spanners, screwdrivers, ladders, ropes
8. Hazard area demarcation equipment and notices.

### C. Disinfection and Sterilization<sup>16</sup>

A sterile item, equipment or solution is completely free of living microorganisms, including endospores, made possible by sterilization. Heat, ethylene oxide gas, hydrogen peroxide gas, plasma, ozone and radiation are used for the said process. Disinfection on the other hand, only eliminates recognized pathogenic microorganisms but not all microbial forms on inanimate objects. Disinfection does not yield the same margin of safety achieved through sterilization. It only reduces the microbial contamination level.

*Table 7.1 Decontamination in Microbiology Lab*

Chemical	Mode	Hazard
Formaldehyde - Paraformaldehyde	gas that kills all microorganisms and spores at temperatures above 20°C; not active against prions; for decontamination and disinfection of enclosed volumes such as safety cabinets and rooms	suspected carcinogen, pungent smell, fumes can irritate eyes and mucous membranes
Hydrogen Peroxide	potent broad-spectrum germicides; safer than chlorine to humans and the environment; decontamination of heat-sensitive medical/surgical devices requires specialized equipment.	corrosive to metals such as aluminum, copper, brass and zinc, and can also decolorize fabrics, hair, skin and mucous membranes
Chlorine Dioxide Gas	fast-acting germicide, disinfectant agent and oxidizer	pungent smell, fumes can irritate eyes and mucous membranes
Alcohols: Ethanol (ethyl alcohol, C <sub>2</sub> H <sub>5</sub> OH) and 2-propanol (isopropyl alcohol, (CH <sub>3</sub> ) <sub>2</sub> CHOH)	active against vegetative bacteria, fungi and lipid-containing viruses but not against spores; should be used at concentrations of approximately 70% (v/v) in water: higher or lower concentrations may not be as germicidal; can be used on skin, work surfaces of laboratory benches and biosafety cabinets, and to soak small pieces of surgical instruments	volatile and flammable and must not be used near open flames

## VIII. Safety Organization and Training

Each laboratory organization should have an implementation of comprehensive safety policy, a safety manual, and supporting programs. The laboratory head or director will assign biosafety officer and other appropriate personnel to certain duties for ensuring safety in a laboratory. However, safety inside a laboratory is also the responsibility of all lab supervisors, employees, and individual workers. Everyone who are working in the laboratory are expected to execute their work safely, and should report any hazardous acts, conditions or incidents to their supervisor. Also, a periodic safety audits done by internal or external personnel are advisable.<sup>16</sup>

### A. Biosafety Officer

On behalf of the head of the laboratory, a biosafety officer is appointed to certain duties and ensure biosafety policies and programs are implemented constantly across the laboratory. A biosafety officer who may be a microbiologist, a technical staff, or any degree taking part in biosafety shall hold the professional capability necessary to propose, assess, and approve particular activities that follow or promotes safe microbiological practices, procedures, and appropriate biocontainment and biosafety measures. The appointed officer must have a technical background in biochemistry, microbiology, and basic physical and biological sciences. It is highly advisable that he/she must also have a knowledge on laboratory and clinical practices and safety, which includes the proper use of containment equipment and facilities as well as its operation and maintenance and provides advice on laboratory design.

He/she should use relevant national and international rules, regulations and guidelines, and help out develop standard operating procedures in the laboratory. Also, the biosafety officer should be able to speak effectively with administrative, technical and support personnel.

The activities of the biosafety officer should include the following:<sup>16</sup>

- Consultations on biosafety, biosecurity and technical compliance
- Internal biosafety audit on technical methods, procedures and protocols, biological agents, materials and equipment done periodically to ensure that laboratory standards are strictly followed.
- Discussions of any significant problems with non-compliance of the Biosafety (Approval and Notification) Regulations 2010 and any important research-related accidents or illnesses, violation of guidelines or procedures with the appropriate persons.
- Authentication that all laboratory workers have received appropriate biosafety training and bio risks have been addressed.
- Provision of continuing or developing biosafety training activities.
- Inspect the circumstances of any accidents or untoward occurrences involving biological agents and ensure that appropriate action is taken.
- Communicate current bio risk issues and possible laboratory-acquired infections with medical staff and other personnel as needed.
- Ensure or develop appropriate emergency plans or decontamination for handling accidental spills or other incidents involving infectious material(s).
- Decontamination is adequately controlled in routine activities, spillages and disposal. Advise on disinfection policy of any apparatus prior to repair or servicing.
- Advise on proper waste disposal.
- Upholding consciousness of community attitudes about health and environmental considerations.
- Establish relevant procedures according to national regulations regarding import/export of pathogenic material to/from the laboratory.
- Ensure compliance with all biological regulations or guidelines relevant to the institution.
- Biosafety aspects of all plans, protocols and operating procedures for research work involving infectious agents shall be reviewed prior to the implementation of these activities

## B. Biosafety Committee

A biosafety committee must be established to develop institutional biosafety policies, codes of practice, and assess research protocols for work requiring infectious agents, animal use, recombinant DNA and genetically modified materials. This is to ensure that such research is done in accordance with the highest standards to protect the health of researchers, the public, and the environment.

The basic biosafety committee may include:<sup>16</sup>

- Biosafety officer(s)
- Scientists
- Medical staffs
- Veterinarian(s) (if work with animals is conducted)
- Technical staff representatives
- Laboratory management representatives

## C. Support Staff

It is important that the personnel are given proper safety training as safe and optimum operation of a laboratory is reliant on the support staff.

### a. Engineering and building maintenance services<sup>16</sup>

Personnel who maintain and repair the structure, facilities and equipment like trained engineers and craftsmen should at least have an idea on the nature of the work of the laboratory, and of safety regulations and procedures.

Testing the efficiency of biological safety cabinets after servicing like new filters have been fitted can be carried out under the supervision of the biosafety officer.

Good relationships with the local service provider and institutions with no internal engineering and maintenance should be established to familiarize them with the equipment and laboratory work.

The biosafety officer and/or the laboratory supervisor should supervise the entry of the engineering and maintenance staff in Biosafety Level 3 or Biosafety Level 4 laboratories.

### b. Cleaning (domestic) services<sup>16</sup>

Biosafety Level 3 and Biosafety Level 4 laboratories should be cleaned by the laboratory staff with clearance and supervision of the biosafety officer and/or the laboratory supervisor.

## D. Training Programs

It is essential that laboratory supervisors and biosafety officer continuously conduct on-the-job safety training programs. This is to sustain safety awareness among laboratory<sup>17</sup> and support staff.

Management commitment, adequate initial job training, good communications, motivational factors, and ultimately the organization's goals and objectives are factors to have an effective biosafety and health training.

The following are significant elements for an effective biosafety training program:<sup>16</sup>

- a. **Needs assessment.** This process includes classifying the tasks involved, the series of importance (according to frequency, criticality, and complexity) and particulars of the phases needed to complete.
- b. **Establishing training objectives.** Objectives acknowledges the conditions under which certain activities or behaviors are performed and the required level of proficiency. These are observable behaviors that the trainee is expected to demonstrate, on the job, after the training.
- c. **Identifying training content and media.** Trainee/s who know or master the job and its demands typically describe the knowledge or skill of the biosafety training program to meet the behavioral objectives. It is unclear that one teaching method (televised instruction, interactive video, computer-aided instruction, lectures, etc.) is higher to another. It considerably depends on specific training needs, the make-up of the trainee group, etc. Other approaches used may focus on or the design of learning measures to correct mistakes people have made in using a skill.
- d. **Accounting for individual learning differences.** Skill levels of individuals and groups differ in literacy, spoken language, culture and pre-trainings. This effective preparation must take into account for a quality characteristics or attributes of a trainee. Characteristics or attributes of the trainees must be considered to have an effective training. There may be difference in aptitude, literacy, culture, spoken language and pre-training skill levels of individuals and groups. Different approaches are used by individuals in improving their job performances. Others learn in written materials while some are more visual learners. Course adaptation for those with hearing impairments and any other special needs of employees must also be addressed. It is also recommended that the developers of any safety training program become familiar with the principles of adult learning.
- e. **Specifying learning conditions.** The instructional events (e.g. training courses, videotapes, written materials, etc.) should not conflict with, inhibit or be unrelated to mastery of the skill or topic being taught. Events (e.g. training courses, videotapes, written materials, etc.) unrelated to mastery of the skill or topic being taught shall be avoided. For example, instead of rote memorization in developing capabilities in problem-solving techniques, the instructional approach should stress on thinking/reasoning approaches.
- f. **Training evaluation.** This governs whether the instruction has an anticipated effect. The most thorough evaluation of a training effort includes assessments for each of the four areas:
  - i. measuring the trainees' reaction to the instruction provided
  - ii. measuring the trainees' recollection and/or performance
  - iii. assessing behavioral change on the job
  - iv. measuring tangible results in terms of the organization's objectives or goals

The trainees' reactions to the instruction is the least efficient method of evaluation as this may bear little relationship to the extent of actual learning. Thus, it should not be used as the only measurement on effectiveness of the training.

- g. **Training revision.** Since multiple criteria are used to quantify results in training program, the training evaluations infrequently show if the training has failed or succeeded. As compared with others, the data indicates a better understanding, retention or application of some parts of the course material. Discrepancies in knowledge and competencies from the training efforts may reveal the consideration of more training with instructional techniques from capable instructors that enlightens the importance of microbiological safety training.

## IX. Disinfection, Sterilization and Safety Checklist

### A. Disinfection and Sterilization

For biosafety in the laboratory, knowledge on disinfection and sterilization is crucial. Specific decontamination requirements depend on the nature of the infectious agent(s) used and the type of experimental work. Contact times for each disinfectant are material- and manufacturer-specific. All recommendations for use should follow the manufacturer's specifications.<sup>17</sup>

#### a. Definitions<sup>17</sup>

Many different terms are used for disinfection and sterilization. The following are among the more common in biosafety:

1. **Antimicrobial** – An agent that kills microorganisms or suppresses their growth and multiplication.
2. **Antiseptic** – A substance that inhibits the growth and development of microorganisms without necessarily killing them. Antiseptics are usually applied to body surfaces.
3. **Biocide** – A general term for any agent that kills organisms.
4. **Chemical germicide** – A chemical or a mixture of chemicals used to kill microorganisms.

5. **Decontamination** – Any process for removing and/or killing microorganisms. The same term is also used for removing or neutralizing hazardous chemicals and radioactive materials.
6. **Disinfectant** – A chemical or mixture of chemicals used to kill microorganisms, but not necessarily spores. Disinfectants are usually applied to inanimate surfaces or objects.
7. **Disinfection** – A physical or chemical means of killing microorganisms, but not necessarily spores.
8. **Microbicide** – A chemical or mixture of chemicals that kills microorganisms. The term is often used in place of “biocide”, “chemical germicide” or “antimicrobial”.
9. **Sporocide** – A chemical or mixture of chemicals used to kill microorganisms and spores.
10. **Sterilization** – A process that kills and/or removes all classes of microorganisms and spores.

Table 9.1 Decontaminants Table<sup>18</sup>

Decontaminant	Gluteraldehyde	Peroxide/ Paracetic Acid/Acetic Acid	Chlorine Dioxide	Chlorine	Iodophor	Alcohol	Phenolic	Quaternary Ammonium Compounds
<b>Classification</b>	Sterilant	Sterilant	Sterilant	High Level	Intermediate	Intermediate	Intermediate	Low Level
<b>Parameters for Use</b>								
<b>Concentration</b>	2%	1%	1:5:1/ 100-1000 ppm	0.01-5%	0.5-2.5%	70-85%	0.2-3%	0.1-2%
<b>Contact Time (min.)</b>	10-600	10-720	10-600	10-30	10-30	10-30	10-30	10-30
<b>Stability &gt; 1 week<sup>1</sup></b>	+		+		+	+	+	+
<b>Agents</b>								
<b>Bacterial Endospores</b>	+	+	+	+/-				
<b>Naked Viruses</b>	+	+	+	+	+	+/- <sup>2</sup>	+/- <sup>2</sup>	
<b>Mycobacterium</b>	+	+	+	+	+	+	+	
<b>Vegetative Bacteria</b>	+	+	+	+	+	+	+	+
<b>Enveloped Viruses</b>	+	+	+	+	+	+	+	+
<b>Characteristics</b>								
<b>Inactivated by Organics</b>		+		+	+	+	+/-	+
<b>Residual</b>	+	+	+	+/-	+		+	
<b>Corrosive</b>		+		+	+		+	
<b>Flammable</b>						+		
<b>Skin Irritant</b>	+	+	+	+	+		+	
<b>Eye Irritant</b>	+	+	+	+	+	+	+	
<b>Respiratory Irritant</b>	+	+	+	+	+	+	+/-	
<b>Toxic</b>	+	+	+	+	+	+	+	+
<b>Use in Biosafety Cabinets</b>								
<b>Routine Surface Decon</b>				+/-	+	+		+
<b>Biohazardous Spill</b>		+/-	+	+/-	+		+	+/-

<sup>1</sup> Protected from light and air<sup>2</sup> Results vary depending on the virus

(+) Effective

(+/-) Limited Effectiveness

() Ineffective

## B. Safety Checklist<sup>19</sup>

This checklist is intended to assist in assessments of microbiological laboratory safety and security status of biomedical laboratories.

### a. Laboratory Premises

1. Have guidelines for commissioning and certification been considered for facility construction or post-construction evaluations?
2. Do the premises meet national and local building requirements, including those relating to natural disaster precautions if necessary?
3. Are the premises generally uncluttered and free from obstructions?
4. Are the premises clean?
5. Are there any structural defects in floors?
6. Are floors and stairs uniform and slip-resistant?
7. Is the working space adequate for safe operation?
8. Are the circulation spaces and corridors adequate for the movement of people and large equipment?
9. Are the benches, furniture and fittings in good condition?
10. Are bench surfaces resistant to solvents and corrosive chemicals?
11. Is there a hand-washing sink in each laboratory room?
12. Are the premises constructed and maintained to prevent entry and harborage of rodents and arthropods?
13. Are all exposed steam and hot water pipes insulated or guarded to protect personnel?
14. Is an independent power support unit provided in case of power breakdown?
15. Can access to laboratory areas be restricted to authorized personnel?
16. Has a risk assessment been performed to ensure that appropriate equipment and facilities are available to support the work being considered?

### b. Storage Facilities

1. Are storage facilities, shelves, etc. arranged so that stores are secure against sliding, collapse or falls?
2. Are storage facilities kept free from accumulations of rubbish, unwanted materials and objects that present hazards from tripping, fire, explosion and harborage of pests?
3. Are freezers and storage areas lockable?

### c. Sanitation and Staff Facilities

1. Are the premises maintained in a clean, orderly and sanitary condition?
2. Is drinking-water available?
3. Are clean and adequate toilet (WC) and washing facilities provided separately for male and female staff?
4. Are hot and cold water, soap and towels provided?
5. Are separate changing rooms provided for male and female staff?
6. Is there accommodation (e.g. lockers) for street clothing for individual members of the staff?
7. Is there a staff room for lunch, etc.?
8. Are noise levels acceptable?
9. Is there an adequate organization for the collection and disposal of general household rubbish?

### d. Heating and Ventilation

1. Is there a comfortable working temperature?
2. Are blinds fitted to windows that are exposed to full sunlight?
3. Is the ventilation adequate, e.g. at least six changes of air per hour, especially in rooms that have mechanical ventilation?
4. Are there HEPA filters in the ventilation system?
5. Does mechanical ventilation compromise airflows in and around biological safety cabinets and fume cupboards?

### e. Lighting

1. Is the general illumination adequate (e.g. 300–400 lux)?
2. Is task (local) lighting provided at work benches?
3. Are all areas well-lit, with no dark or ill-lit corners in rooms and corridors?



4. Are fluorescent lights parallel to the benches?
5. Are fluorescent lights color-balanced?

#### f. Services

1. Is each laboratory room provided with enough sinks, water, electricity and gas outlets for safe working?
2. Is there an adequate inspection and maintenance program for fuses, lights, cables, pipes, etc.?
3. Are faults corrected within a reasonable time?
4. Are internal engineering and maintenance services available, with skilled engineers and craftsmen who also have some knowledge of the nature of the work of the laboratory?
5. Is the access of engineering and maintenance personnel to various laboratory areas controlled and documented?
6. If no internal engineering and maintenance services are available, have local engineers and builders been contacted and familiarized with the equipment and work of the laboratory?
7. Are cleaning services available?
8. Is the access of cleaning personnel to various laboratory areas controlled and documented?
9. Are information technology services available and secured?

#### g. Laboratory Biosecurity

1. Has a qualitative risk assessment been performed to define risks that a security system should protect against?
2. Have acceptable risks and incidence response planning parameters been defined?
3. Is the whole building securely locked when unoccupied?
4. Are doors and windows break-proof?
5. Are rooms containing hazardous materials and expensive equipment locked when unoccupied?
6. Is access to such rooms, equipment and materials appropriately controlled and documented?

#### h. Fire Prevention and Fire Protection

1. Is there a fire alarm system?
2. Are the fire doors in good order?
3. Is the fire detection system in good working order and regularly tested?
4. Are fire alarm stations accessible?
5. Are all exits marked by proper, illuminated signs?
6. Is access to exits marked where the routes to them are not immediately visible?
7. Are all exits unobstructed by decorations, furniture and equipment, and unlocked when the building is occupied?
8. Is access to exits arranged so that it is not necessary to pass through a high-hazard area to escape?
9. Do all exit lead to an open space?
10. Are corridors, aisles and circulation areas clear and unobstructed for movement of staff and fire-fighting equipment?
11. Is all fire-fighting equipment and apparatus easily identified by an appropriate color code?
12. Are portable fire extinguishers maintained fully charged and in working order, and kept in designated places at all times?
13. Are laboratory rooms with potential fire hazards equipped with appropriate extinguishers and/or fire blankets for emergency use?
14. If flammable liquids and gases are used in any room, is the mechanical ventilation sufficient to remove vapors before they reach a hazardous concentration?
15. Are personnel trained to respond to fire emergencies?

#### i. Compressed and Liquefied Gases

1. Is each portable gas container legibly marked with its contents and correctly color-coded?
2. Are compressed-gas cylinders and their high-pressure and reduction valves regularly inspected?
3. Are reduction valves regularly maintained?
4. Is a pressure-relief device connected when a cylinder is in use?
5. Are protection caps in place when cylinders are not in use or are being transported?
6. Are all compressed gas cylinders secured so that they cannot fall, especially in the event of natural disaster?

7. Are cylinders and liquid petroleum gas tanks kept away from sources of heat?
8. Are personnel trained to properly use and transport compressed and liquefied gases?

#### j. Electrical Hazards

1. Are all new electrical installations and all replacements, modifications or repairs made and maintained in accordance with a national electrical safety code?
2. Does the interior wiring have an earthed/grounded conductor (i.e. a three-wire system)?
3. Are circuit-breakers and earth-fault interrupters fitted to all laboratory circuits?
4. Do all electrical appliances have testing laboratory approval?
5. Are the flexible connecting cables of all equipment as short as practicable, in good condition, and not frayed, damaged or spliced?
6. Is each electric socket outlet used for only one appliance (no adapters to be used)?

#### k. Personal Protection

1. Is protective clothing of approved design and fabric provided for all staff for normal work, e.g. gowns, coveralls, aprons, gloves?
2. Is additional protective clothing provided for work with hazardous chemicals and radioactive and carcinogenic substances, e.g. rubber aprons and gloves for chemicals and for dealing with spillages; heat-resistant gloves for unloading autoclaves and ovens?
3. Are safety glasses, goggles and shields (visors) provided?
4. Are there eye-wash stations?
5. Are there emergency showers (drench facilities)?
6. Is radiation protection in accordance with national and international standards, including provision of dosimeters?
7. Are respirators available, regularly cleaned, disinfected, inspected and stored in a clean and sanitary condition?
8. Are appropriate filters provided for the correct types of respirators, e.g. HEPA filters for microorganisms, appropriate filters for gases or particulates?
9. Are respirators fit-tested?

#### l. Health and Safety of Staff

1. Is there an occupational health service?
2. Are first-aid boxes provided at strategic locations?
3. Are qualified first-aiders available?
4. Are such first-aiders trained to deal with emergencies peculiar to the laboratory, e.g. contact with corrosive chemicals, accidental ingestion of poisons and infectious materials?
5. Are non-laboratory workers, e.g. domestic and clerical staff, instructed on the potential hazards of the laboratory and the material it handles?
6. Are notices prominently posted giving clear information about the location of first-aiders, telephone numbers of emergency services, etc.?
7. Are women of childbearing age warned of the consequences of work with certain microorganisms, carcinogens, mutagens and teratogens?
8. Are women of childbearing age told that if they are, or suspect that they are, pregnant they should inform the appropriate member of the medical/scientific staff so that alternative working arrangements may be made for them if necessary?
9. Is there an immunization programme relevant to the work of the laboratory?
10. Are skin tests and/or radiological facilities available for staff who work with tuberculous materials or other materials requiring such measures?
11. Are proper records maintained of illnesses and accidents?
12. Are warning and accident prevention signs used to minimize work hazards?
13. Are personnel trained to follow appropriate biosafety practices?
14. Are laboratory staff encouraged to report potential exposures?

#### m. Laboratory Equipment

1. Is all equipment certified safe for use?
2. Are procedures available for decontaminating equipment prior to maintenance?
3. Are biological safety cabinets and fume cupboards regularly tested and serviced?

4. Are autoclaves and other pressure vessels regularly inspected?
5. Are centrifuge buckets and rotors regularly inspected?
6. Are HEPA filters regularly changed?
7. Are pipettes used instead of hypodermic needles?
8. Is cracked and chipped glassware always discarded and not reused?
9. Are there safe receptacles for broken glass?
10. Are plastics used instead of glass where feasible?
11. Are sharps disposal containers available and being used?

#### n. Infectious Materials

1. Are specimens received in a safe condition?
2. Are records kept of incoming materials?
3. Are specimens unpacked in biological safety cabinets with care and attention to possible breakage and leakage?
4. Are gloves and other protective clothing worn for unpacking specimens?
5. Are personnel trained to ship infectious substances according to current national and/or international regulations?
6. Are work benches kept clean and tidy?
7. Are discarded infectious materials removed daily or more often and disposed of safely?
8. Are all members of the staff aware of procedures for dealing with breakage and spillage of cultures and infectious materials?
9. Is the performance of sterilizers checked by the appropriate chemical, physical and biological indicators?
10. Is there a procedure for decontaminating centrifuges regularly?
11. Are sealed buckets provided for centrifuges?
12. Are appropriate disinfectants being used? Are they used correctly?
13. Is there special training for staff who work in containment laboratories – Biosafety Level 3 and maximum containment laboratories – Biosafety Level 4?

#### o. Chemicals and Radioactive Substances

1. Are incompatible chemicals effectively separated when stored or handled?
2. Are all chemicals correctly labelled with names and warnings?
3. Are chemical hazard warning charts prominently displayed?
4. Are spill kits provided?
5. Are staff trained to deal with spills?
6. Are flammable substances correctly and safely stored in minimal amounts in approved cabinets?
7. Are bottle carriers provided?
8. Is a radiation protection officer or appropriate reference manual available for consultation?
9. Are staff appropriately trained to safely work with radioactive materials?
10. Are proper records of stocks and use of radioactive substances maintained?
11. Are radioactivity screens provided?
12. Are personal radiation exposures monitored?

## References:

- <sup>1</sup> Biosafety in Microbiology and Biomedical Laboratories. U.S. Department of Health and Human Services. HHS Publication No. (CDC) 21-1112. 5th Edition. December 2009. pp 1-19.
- <sup>2</sup> Biosafety in Microbiology and Biomedical Laboratories. U.S. Department of Health and Human Services. HHS publication (CDC) 99-8395. 4th Edition. April 1999. pp 52-53.
- <sup>3</sup> Biosafety Handbook. The Regents of the University of California, USA. 1996. p 37.
- <sup>4</sup> Biosafety in Microbiology and Biomedical Laboratories. U.S. Department of Health and Human Services. HHS publication (CDC) 99-8395. 4th Edition. April 1999. pp 22-29.
- <sup>5</sup> World Health Organization. Laboratory Biosafety Manual. 3rd Edition. 2004. Geneva, World Health Organization. pp 5-25
- <sup>6</sup> Biosafety in Microbiology and Biomedical Laboratories. U.S. Department of Health and Human Services. HHS Publication No. (CDC) 21-1112. 5th Edition. December 2009. pp 30-51.
- <sup>7</sup> Field Certification of Biosafety Cabinets to NSF/ANSI Standard 49-2014 Biosafety Cabinetry: Design, Construction, Performance, and Field Certification. NSF International. 2015.  
*Retrieved from [http://www.nsf.org/newsroom\\_pdf/NSF\\_Biosafety\\_Cabinet\\_Memo\\_Canopy\\_Connections.pdf](http://www.nsf.org/newsroom_pdf/NSF_Biosafety_Cabinet_Memo_Canopy_Connections.pdf)*
- <sup>8</sup> Esco Biological Safety Cabinets. Your Protection from Biohazards. Esco Micro Pte Ltd. 2016.
- <sup>9</sup> Esco Guide to Biosafety & Biological Safety Cabinets. Esco Micro Pte Ltd. 2013.
- <sup>10</sup> Hazard Analysis and Risk-based Preventive Controls for Human Food: Draft Guidance for Industry. US FDA.  
*Retrieved from <https://www.fda.gov/downloads/Food/GuidanceRegulation/FSMA/UCM517396.pdf>*
- <sup>11</sup> Radiological Hazards. Food Safety Experts. 2016.  
*Retrieved from <https://www.foodsafetyexperts.com/algemeen/radiological-hazards/>*
- <sup>12</sup> NSF International. NSF-ANSI 49-2016 Biosafety Cabinetry: Design, Construction, Performance and Field Certification. 2017. PO Box 130140, Ann Arbor, Michigan 48113-0140, USA.
- <sup>13</sup> EN12469:2000. Biotechnology-Performance Criteria for Microbiological Safety Cabinets. European Committee for Standardization. 2002.
- <sup>14</sup> Lin, XQ. Comparison Between EN 12469:2000 and ANSI/NSF49:2002 Standards. Esco Micro Pte Ltd. 2002.  
*Retrieved from [http://www.escoglobal.com/resources/pdf/whitepapers/comparison\\_between\\_NSF49\\_and\\_EN12469.pdf](http://www.escoglobal.com/resources/pdf/whitepapers/comparison_between_NSF49_and_EN12469.pdf)*
- <sup>15</sup> World Health Organization. Laboratory Biosafety Manual. 3rd Edition. 2004 Geneva, World Health Organization. pp 67-93.
- <sup>16</sup> World Health Organization. Laboratory Biosafety Manual. 3rd Edition. 2004. Geneva, World Health Organization. pp 117-121.
- <sup>17</sup> World Health Organization. Laboratory Biosafety Manual. 3rd Edition. 2004. Geneva, World Health Organization. pp 82-83.
- <sup>18</sup> Esco Guide to Biosafety & Biological Safety Cabinets. Esco Micro Pte Ltd. 2013. p 19.
- <sup>19</sup> World Health Organization. Laboratory Biosafety Manual. 3rd Edition. 2004. Geneva, World Health Organization. pp 125-131.

# ESCO LIFESCIENCES GROUP

42 LOCATIONS IN 21 COUNTRIES ALL OVER THE WORLD

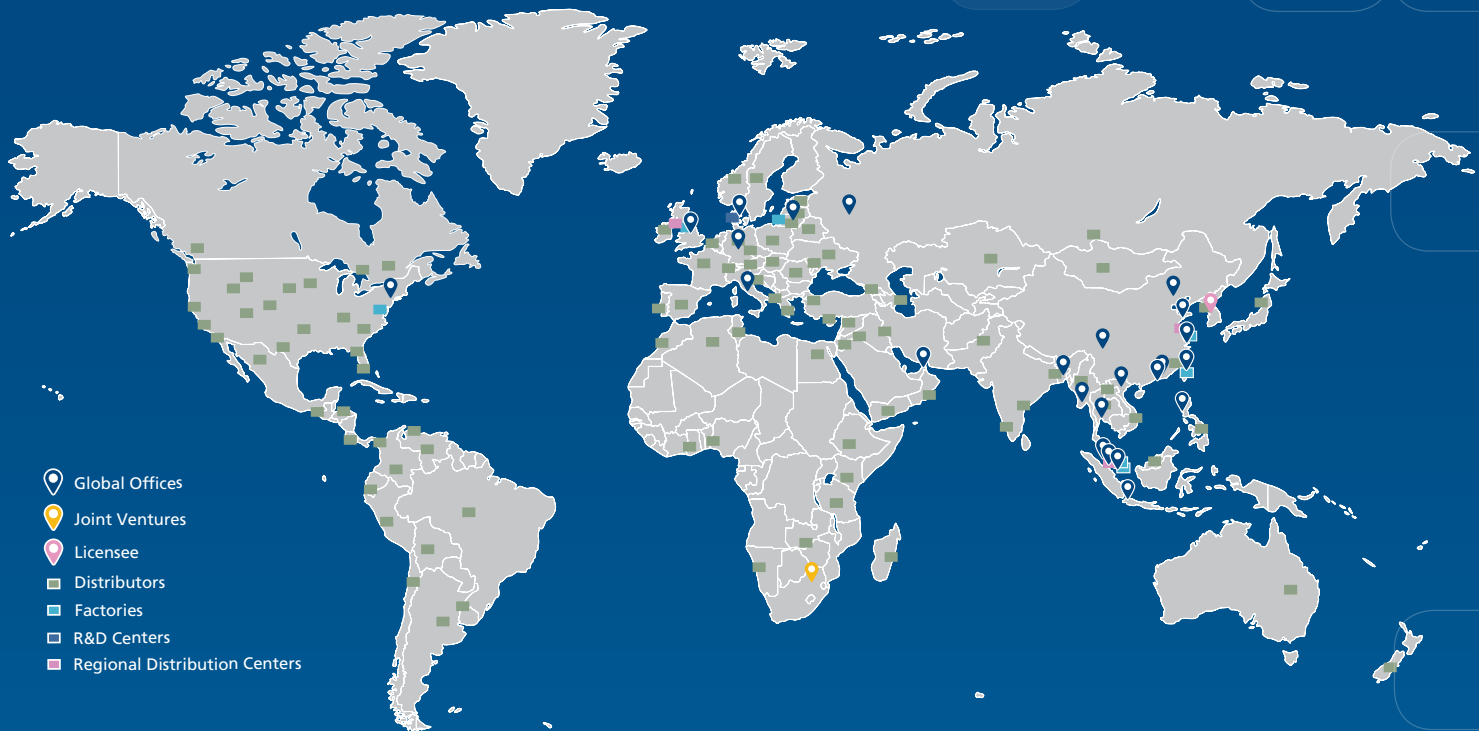

-  Global Offices
-  Joint Ventures
-  Licensee
-  Distributors
-  Factories
-  R&D Centers
-  Regional Distribution Centers

Join us on Social Media and Download our Apps!

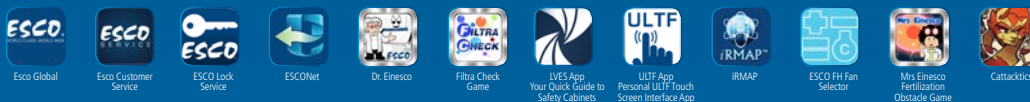

Filtra Check App  
The World's First Chemical  
Evaluation App



Esco Social Media  
and Apps



Esco Micro Pte. Ltd. • 21 Changi South Street 1 • Singapore 486 777  
Tel +65 6542 0833 • Fax +65 6542 6920 • mail@escolifesciences.com  
www.escolifesciences.com

Esco Technologies, Inc. • 903 Sheehy Drive, Suite F, Horsham, PA 19044, USA  
Tel: +1 215-441-9661 • Fax 484-698-7757  
eti.admin@escolifesciences.com

Esco Lifesciences Group Offices: Bangladesh | China | Denmark | Germany | Hong Kong | India | Indonesia | Italy | Japan | Lithuania | Malaysia | Myanmar | Philippines | Russia | Singapore | South Africa | South Korea | Taiwan | Thailand | UAE | UK | USA | Vietnam